



Clean & Medical Lighting

LUXIONA

EN

Index

2	Our values
4	Competitive manufacturing
6	Luxiona Clean room manufacturing
8	Lighting Consulting
9	Sustainable solutions. Innovative technology
10	Customise and go beyond the standards
28	From extreme to standard clean requirements
36	UVC disinfection lighting
42	Hospital lighting solutions for every space
46	Clean manufactory solutions for every space
88	Selection of luminaires for hospitals
91	Selection of luminaires for clean manufactory
98	Chosen projects for Clean & Medical around the world
100	LUXIONA worldwide

LUXIONA



Our values

Personalised solutions and European design

Created in Barcelona, Spain, and developed in Poland, our products combine European design with high quality and efficiency. At the very Centre of our work is our passion for lighting and functional design. The highest performance aligned with aesthetics and simplicity of installment and maintenance makes it a perfect solution for any space.

Thanks to a variety of customisable options it is possible to adjust our products to the needs of a specific project, including the most demanding medical facilities as well as pharmaceutical, electronic, chemical and food industry, that require the highest degree of cleanliness.



Basilica della Sagrada Família, Barcelona. Spagna (Design Antonio Gaudí)

Designed in Barcelona

From the moment we started our company in Barcelona in 1929, the value of design has been part of Luxiona's soul. Since the invention of the first electrified rail system inspired by the trolleybuses on the streets of Barcelona, the source of inspiration for our products is based on this city that exudes design, art and avant-garde. We have an international presence with offices in Spain, France, Italy, Germany and

Poland, but it is here in Barcelona where the research and product development team is located to keep the initial spirit alive in each of our luminaires, always with the highest level of sustainable technologies. The results are lighting solutions that offer a comfortable visual experience, positively influencing people's well-being and at the same time respecting the environment.



DESIGN PLUS



Luxiona Main Factory, Jacentow. Poland

Competitive manufacturing

By combining design in Barcelona with production in Europe, Luxiona provides customers with competitive, flexible and timely solutions.

A certified production plant for clean and medical luminaires and logistics centre located in Poland allows us to be independent and offer fast turnaround times, as well as better communication and advice. Our infrastructure and technical equipment are constantly updated to offer continuous improvement of production. With our on-site

certified clean room we are one of the few manufacturers in Europe in full control of the production process, while maintaining the necessary standards to certify our luminaires for installations requiring a high degree of cleanliness atmosphere, including ISO 14644-1 certification for clean rooms.

As a result, our product range covers different sectors: architectural, office, industrial, sports, retail, clean rooms, medical and hospital facilities, as well as for the pharmaceutical, chemical, food and electronics industries.



Luxiona Main Factory, Jacentow. Poland

ISO
13485

Clean and medical ISO 13485 certified factory in Jacentow

Luxiona's production plant is fully equipped with technologies enabling us to disinfect and prepare the luminaires according to ISO standards. Our production process requires not only the highest standards but also a broad machinery park and separate rooms dedicated to manufacturing clean and medical products.

The experience gathered through years combined with the development of modern solutions results in a wide variety of products. We are also able to provide short realisation terms, thanks to independence from external factors and the complexity of our technologies that ensure the flexibility of our production process.

Certificate ISO 14001:2015



Certificate ISO 9001:2015

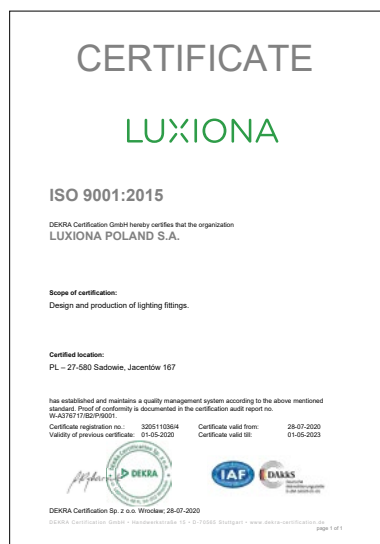

Certificate ISO 13485:2012





Luxiona Main Factory, Jacentow. Poland

Luxiona Clean room manufacturing

Cleanroom technology offers a broad range of solutions, creating an atmosphere as sterile as possible. To achieve the safety and best results both in medical facilities and in industries it is important to ensure the correct clean room conditions.

Used in a wide variety of manufacturing areas clean room technology is present from chemistry, pharmaceuticals through precision engineering and microelectronics, biological laboratories and food industry. All these different applications involve a wide range of different tasks: from illuminating a patient recovery room or operating theatre to high illuminance levels in laboratories, a range of applications in terms of specific industry requirements is diverse. In all cases the pollution by particles classified as contamination is strictly controlled: no matter how small they are, the number of airborne dust particles, bacteria, viruses, and chemical vapours must be as small as possible.

The purpose of clean-room technology is to protect patients and processes as well as manufactured products against contamination of any sort. The contamination is strictly monitored even in the clean room premises that have dimensions of a production hall and a surface of a few thousand square meters. These kinds of premises are commonly used during the production process of precise semiconductors, biotechnology, and other fields in which even tiny pollution is a critical parameter of technology.

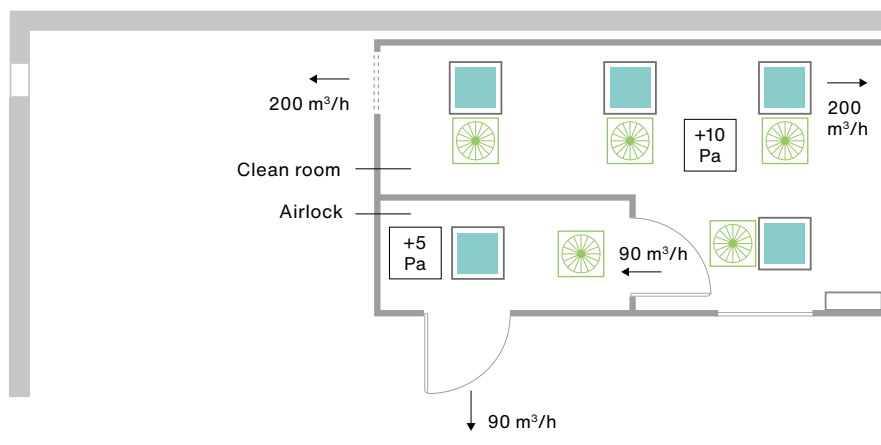

- Lighting luminaire Agat Clean No Frame
- Swirl diffuser with H13 air filter (air volumes up to 375 m³/h)
- +5 Pa Overpressure in the room
- 200 m³/h Air flow through the crevice in the door and through process holes

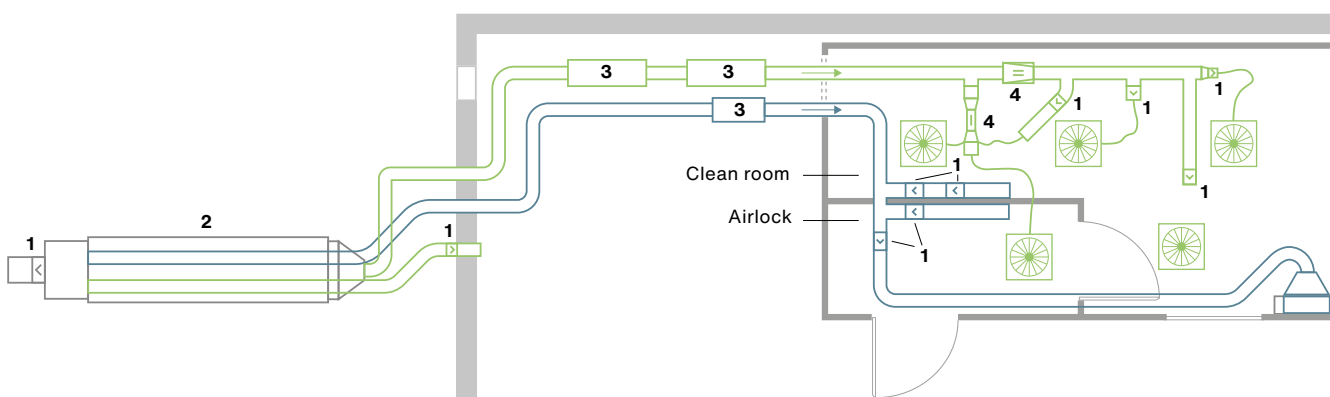

- Air diffusion
- Air return
- Flexible pipe
- 1. Regulating damper
- 2. Air handling system: diffusion, indoor, hygienic
- 3. Air duct noise silencer
- 4. Constant air volume regulator

Our clean room technology

In our clean room manufacturing premises the air is pumped inside the clean room through a special system of filters which eliminate subsequent fractions of pollution. The air inside the room is continuously filtered by a set of HEPA filters in order to remove the pollution created inside. The employees entering and exiting the room have to do it through the airlock. The employees inside the clean room should wear all

the time protective suits, masks, and shoes. In less expensive solutions there is no air lock-the entrance is directly from the antechamber where a protective suit is worn. The devices inside a clean room have to be specially designed so as not to generate additional pollution. It applies also to luminaires which are produced in our production plant in specially prepared conditions.

Lighting Consulting

Our team of 20+ experts is always available in each country of our presence and will accompany you in developing your lighting projects. We provide personalised advice, specific for clean room lighting, based on experience and know-how gathered throughout the years. Thanks to complete follow-up of the project's needs until its implementation we offer you a global and integral vision at every stage. Our certified Dialux trainer, with always up-to-date knowledge is available for you to help you with your project and to train your design team. A personal approach to every project is at the centre of our work and leads to a partnership that results in top-quality projects.

Customer and project requirements

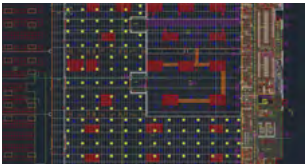

Stage 1

Stage 1: Plan with proposed distribution of luminaires. Detailed plans with sections, cuts, ceiling typology and furniture. Functions, branding, ambience, experience, sensations, levels and creation of environments. BIM methodology.

Lighting consulting, conceptualisation and project development Analysis and review of plans and needs

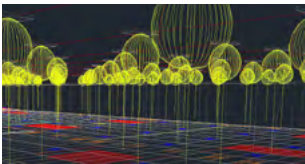

Stage 2

Stage 2: Initial sketch of the lighting study. Plans with proposed location of luminaires. Lighting study and calculation (3D modelling). Carrying out lighting calculations to adjust and validate the proposal and the lighting levels, sensations, consumption control and efficiency. Development of special projects and products.

Presentation and delivery of the project

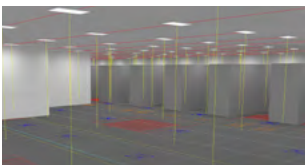

Stage 3

Stage 3: Lighting levels represented in false colours. Luminaire location plan (PDF and CAD). Technical data sheets of the applied products. Control and Smart Lighting services: Creation of groups and scenes, location of sensors, sketches and electrical diagrams, configuration, etc.

Technical support and customer service

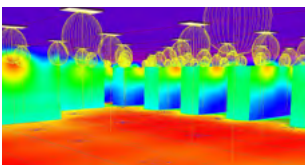

Stage 4

Stage 4: Lighting simulation result of the final project. Follow-up of work and supervision of the installation and configurations. Incident management. Maintenance and repairs. Programming and commissioning of regulation and control systems.

Sustainable solutions

Sustainability is at the very core of responsible businesses. By working together we strive to develop projects that have a positive impact on the environment and promote sustainable lighting so important for modern facilities in the clean room industries, where efficiency and energy-saving is one of the most crucial factors. We are able to achieve this by using intelligent switching control systems and by providing users with efficient, and sustainable solutions.

One of them are LED sources used in Luxiona luminaires, characterised by a long lifespan of 100,000 h and the LxBy parameter at the L80B10 level. This means that after 100,000 hours of use, the LED sources will retain 80% of their initial luminous flux, and only 10% of the LEDs will have less than 80% of their initial luminous flux. This means that we can enjoy their quality longer.

Innovative technology

Innovations and functionality have always been and will remain an important factor in the development of new lighting solutions, services, and the application of new technologies. The know-how accumulated after almost half a century of experience and the combination of design and engineering allows us to stay one step ahead.

Together with our R+D+i department, in constant search for new lighting solutions, we are able to use the latest generation of materials and production processes. Looking to the future combined with our experience allow us to shape the lighting of the future and expand our innovative product portfolio.



Certification programmes for green buildings



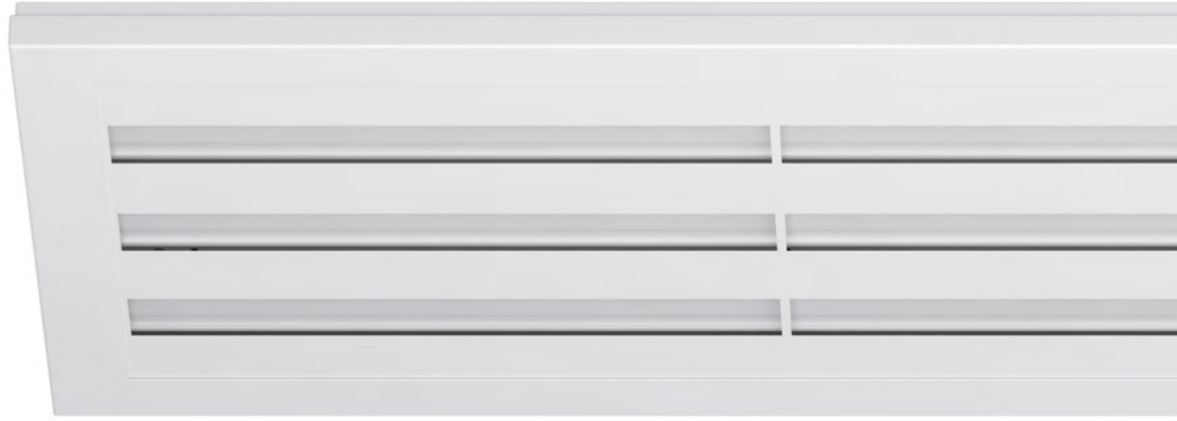

Customise and go beyond the standards

We leave nothing to chance. By listening, understanding, and combining our knowledge and experience we make the most of available possibilities. By anticipating the specific needs of investors, architects and designers especially focused on the clean room projects we are able to meet all the requirements of every project.

The wide range of customisable solutions has a number of applications specifically developed by our experts to meet demanding needs of clean room both in medical facilities and in industries requiring a high degree of cleanliness of the atmosphere.



Light

Colour temperature

From warm to cool, reproduces the colour of natural light to help recovering patients restore their natural sleep and awake biorythm.

Colour rendering

Reproduces the real colours of an object. In medical facilities, the correct rendering of the skin and blood colour is crucial.

Lumen

The amount of visual light emitted is especially important in medical applications where high trough-puts are needed in critical areas such as surgery.

Diffuser

Gives a wide choice to control the emission and protect the fitting against the dust and moisture, especially important in industry requiring high level of cleanliness.

Optic

The way the light is directed, implies managing reflections to have most of light where is needed whilst not disturbing patients in bed units. Also it is very important to correct with the help of optics, directing the light where appropriate, in such rooms where the designer cannot freely place luminaires due to normative constraints.

Emission

Optimising light output to achieve best performance comfort and wellness. Direct, undirect and Up&Down.



Gear

Control

On/off, dim light on request.

Endurance

Adapt lifespan to project needs even in hard conditions.

Emergency

Safety by lighting even when there is no electrical supply.

Sensors

Interaction in realtime between lighting and application environment.



Body

Size

Dimension adjusted to specific project.

Material

Sheet steel, stainless steel
Protection: IP, IK.

Finishing

Standard RAL 9016 white colour, any other RAL colour on request. Coloured luminaires are particularly recommended for children's wards in hospitals. Special luminaires coatings: antibacterial - crucial for high degree cleanliness rooms and anti-reflective - recommended for operating theaters where a laser light beam is used.

Installation

Installation in suspended ceilings with modular structure, in plasterboard ceilings, directly on the fixed ceiling or on the wall. Luminaires can be adapted to different types of ceilings with different module sizes. Suitable for installation in technical ceilings where lighting maintenance can be carried out directly without entering the room, which is particularly important in clean rooms.

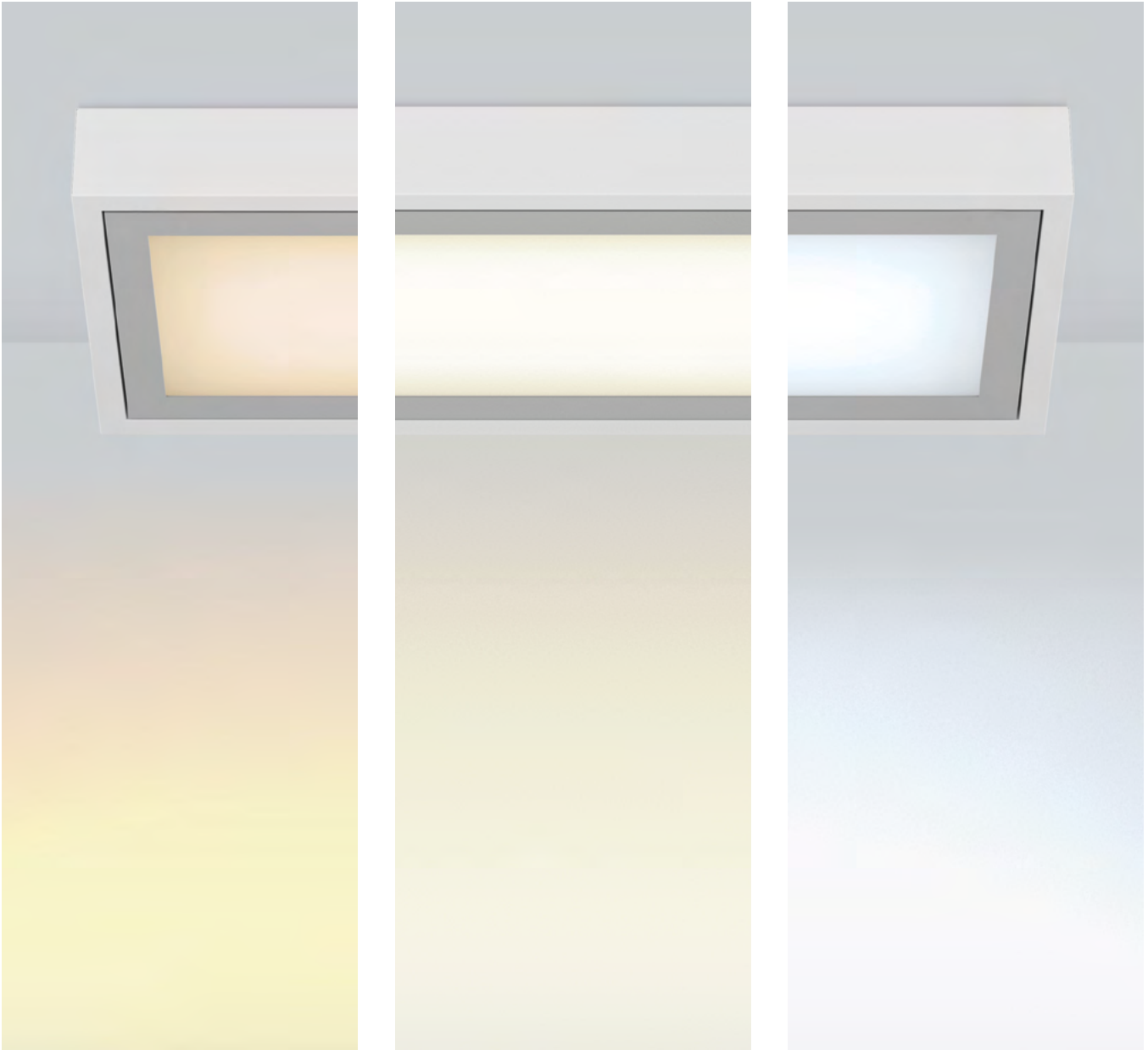

Tunable White

An increasing number of scientific studies confirm the effects of light on different areas of our lives. The intensity of light and its spectrum plays also a very important role in both our physical and mental wellbeing. In order to ensure the right intensity of light and right colour temperature of artificial light, and also aligning it with the natural light at a given time of day, Tunable White is a perfect solution. This technology is available

in Luxiona luminaires and LED modules installed in Clean luminaires, which brings Human Centric Lighting solutions to clean, and medical rooms. The use of technology allows to follow natural circadian rhythm. Well adjusted lighting to specific needs helps patients restore their natural biorhythm thanks to suppressing or increasing production of melatonin. Correct lighting is also crucial for medical staff to stay alert and focused during long shifts.

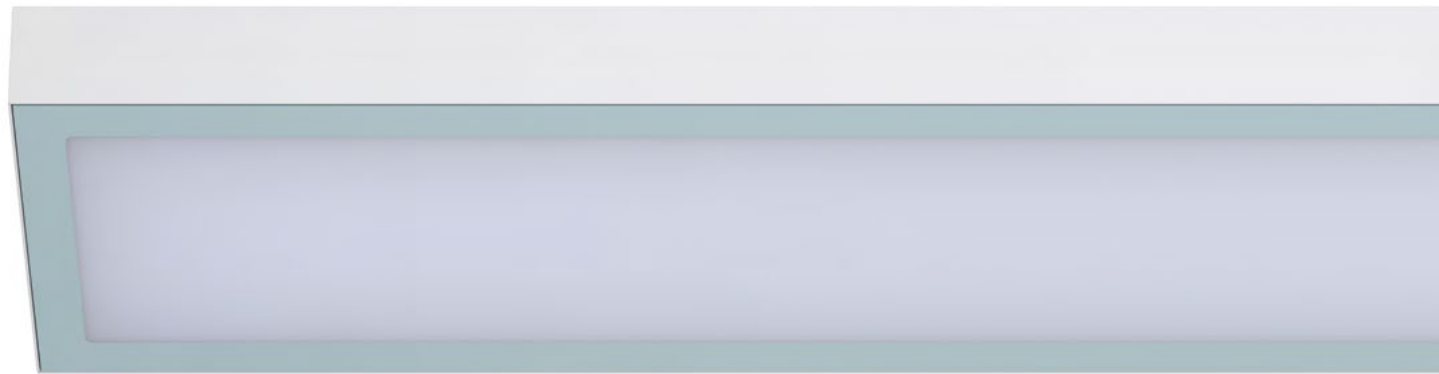
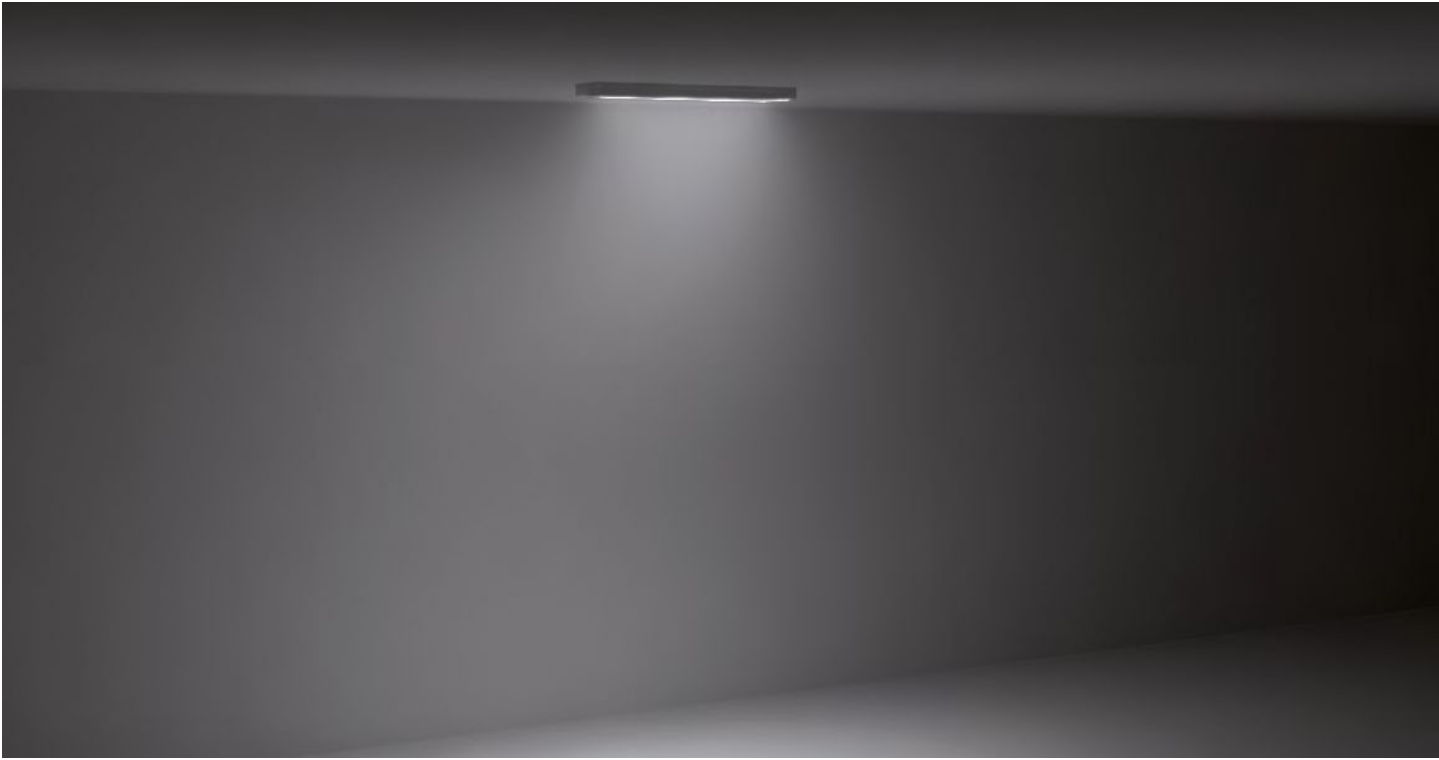

Rubin Clean No Frame



Exceeding lighting standards

Adjust the luminaire's luminous flux to achieve the ideal light intensity and its uniformity. Select the luminaire with the appropriate light distribution to easily meet the required lighting standards.

Correct beam angle will help achieve the appropriate level of average illuminance and its uniformity by using luminaires with lower energy consumption. The right optical control provides comfort for optimal conditions in spacious production halls in the pharmaceutical, electronic, chemical and food industries. This means savings for the investor when

purchasing luminaires as well as lowering the cost of operating the lighting. Correct optical system allows reducing glare, to meet the required standards for specific medical or industrial facilities. To achieve this, choose a product with Micro-PRM or a luminaire with an anti-glare louver.



Colour rendering index (CRI)

Competitive lighting solutions with the highest colour rendering index.

LUXIONA is one of the few manufactories in Europe to achieve a CRI>95 for its luminaires (with a high value of the R9 and R13 component, perfectly reflecting the colour of tissue and blood). The luminaire is recommended for operating theatres, where the lighting used should ideally reflect the colours of skin, blood and tissues (high R9 - responsible for rendering 'deep red' and R13 - responsible for rendering 'light orange'). CRI and its definition has to do with the concept of the 'standard observer' and the way the human eye sees colours. To establish that a table of 14 TCS (Test Colour Samples) was created. These colours, designated as TCS1 to TCS14 are

illuminated with test light. This way it's possible to determine the extent to which the light reflected from the test colours is similar to the reflection of the reference light. This produces colour-rendering coefficients R1 to R14, which represent the respective colours TCS1 to TCS14. These coefficients can also be calculated from the spectral characteristics of the light source.

For a reference light, the coefficients R1 to R14 are equal to 100.

The greater the difference between the reflectance of the test light and that of the reference light for a particular TCS colour, the smaller the corresponding coefficient.

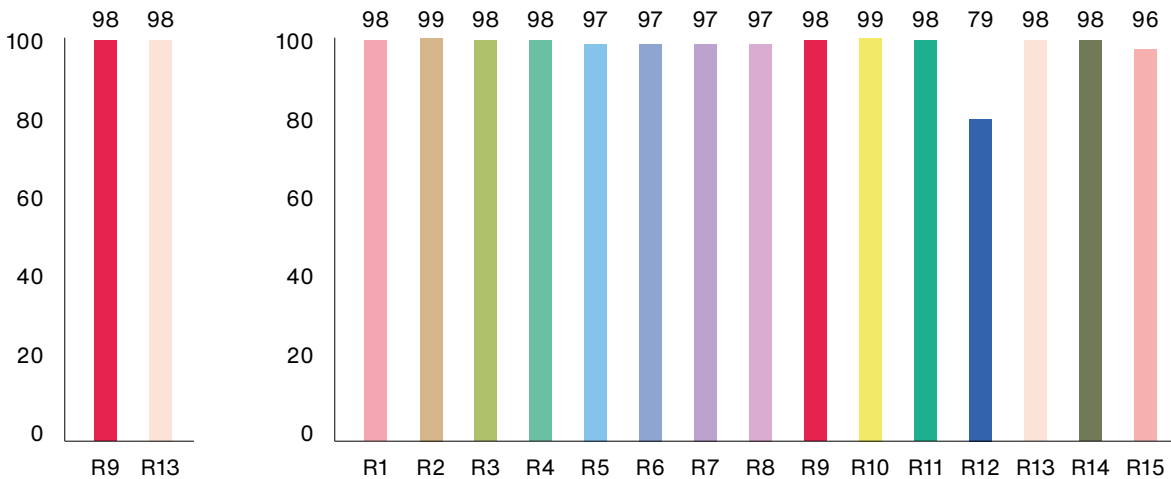

CRI 98,2	LUXIONA's modules and simultaneous preservation of high components
R9	responsible for rendering "deep red" colour (colour of blood)
R13	responsible for rendering "light orange" (colour of tissues)

CCT	3926K
CRI	98,2
λp	642 nm
PFlicker	1,15%



Clean luminaire CRI95 medical device

Legal requirements

Luxiona medical device luminaires are registered in the Office for Registration of Medicinal Products, Medical Devices and Biocidal Products. Luminaires are compatible with requirements defined in directives of European Union: Directive of the Council 93/42/EEC (MDD), the Directive of European Parliament and the Council 2007/47/EC. Our clean luminaire - medical device fulfils also the requirements defined in the bill of February 3rd 2017 about Medical Products. Products are tested and compatible with European norm PN-EN 60601-1, PN-EN 60601-1-2, concerning medical electric devices- overall safety requirements and basic technical requirements.

Production process

Our certified luminaires - medical devices, require specially dedicated technological line and individual production process, that ensures

the conformity of the products during the design process and production with all requirements. They concern among other things the safety of the products and hazards related to product usage. The production technology is also under restrictive procedures of high quality control, provided by the Office for Registration of Medicinal Products, Medical Devices and Biocidal Products. The quality control includes all stages- from the design and manufacturing of medical product till the moment when the luminaire is placed on the market or used.

Application:

Luminaire is destined for use in:

1. Operating rooms
2. Intensive medical care rooms
3. Rooms dedicated for laparoscopic and endoscopic treatments
4. Recovery rooms
5. Dermatological clinics
6. Blood sampling points

Product characteristics

1. Anti-reflective C56 which minimalises the reflection of the laser light beam on request.
2. Laminated matt pane with anti-reflective coating-SLMR.
3. Hardened matt pane with anti-reflective coating-SHMR.
4. Micro-prismatic diffuser with laminated anti-reflective pane-Micro PRM SLR.
5. Diffusers resistant to disinfectants, ammonium salt, hydrogen peroxide, chlorine and UV radiation.
6. Laminated matt pane-SLM.
7. Hardened matt pane-SHM.
8. Micro-prismatic diffuser with laminated pane-Micro-PRM SL.
9. Micro-prismatic diffuser with hardened pane-Micro-PRM SH.
10. Antibacterial coating preventing from micro-organisms.
11. Light source of the colour rendering index equal or higher than 95.





Colours for each clean industry

Matching the LED light sources to the expectations of the project or investor can require luminaires equipped with non-standard light sources, for example with a very warm colour of 2700 K, or with Tunable White light sources or a special colour of LED for specific applications.

LED of special spectrum for specific applications:

- Green** - laparoscopic surgery
- Yellow** - pharmaceuticals, production of electronic (e.g. microchips)

- Red** - laboratories to observe animals
- Blue** - meat industry
- UV** - disinfection
- Other** - plant cultivation, animal farming, human treatment

Yellow + white 830/840*

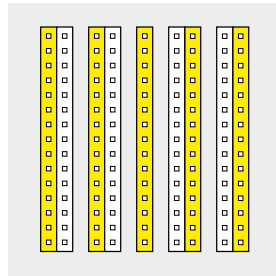

Yellow

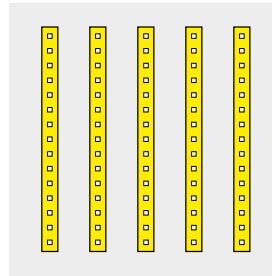

Red + white 830/840*

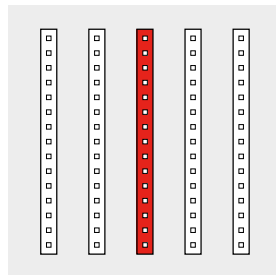

Green + white 830/840*

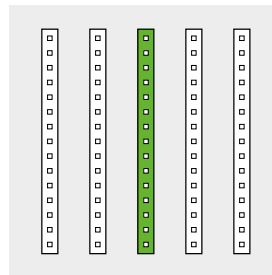

Blue + white 830/840*

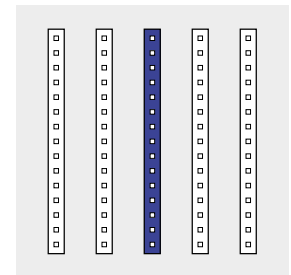

Red + green + blue**

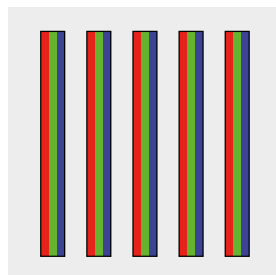

* Two independent circuits



Hybrid Room at the Provincial Specialist Hospital, Olsztyn. Poland



Hybrid Room at the Provincial Specialist Hospital, Olsztyn. Poland 17

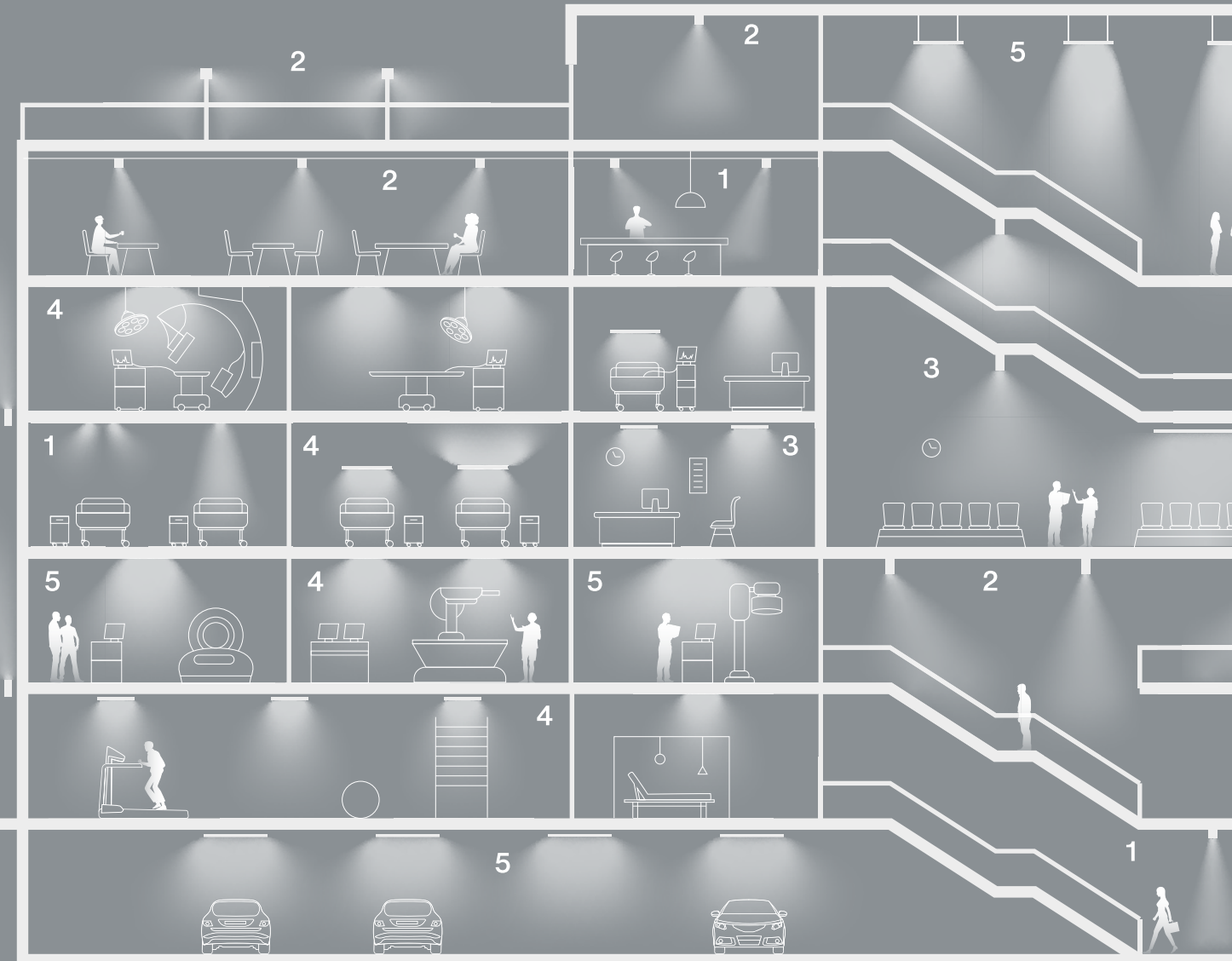

Solutions tailored to any space

The full availability of product families with customisable optical systems enables a wide variety of light distribution and helps to comply with lighting standards and investor requirements in any clean or medical facilities. We are aware that in some projects standard solutions will not be enough that's why we are open to create new personalised solutions. Our know-how helps us do it regardless of how challenging the project may seem. Choosing functional lighting was never that simple. Starting

from operating theatres - surgery rooms, surroundings of operating theatres, intensive care rooms, blood extraction rooms, patient rooms, common areas: corridors, waiting areas, receptions, underground car parks, and gardens - there are many possibilities to personalise and adjust the solution to a specific medical area or clean industry.

Recessed	Front access for maintenance	Agat
	Rear access for maintenance	Topaz
Surface		Rubin

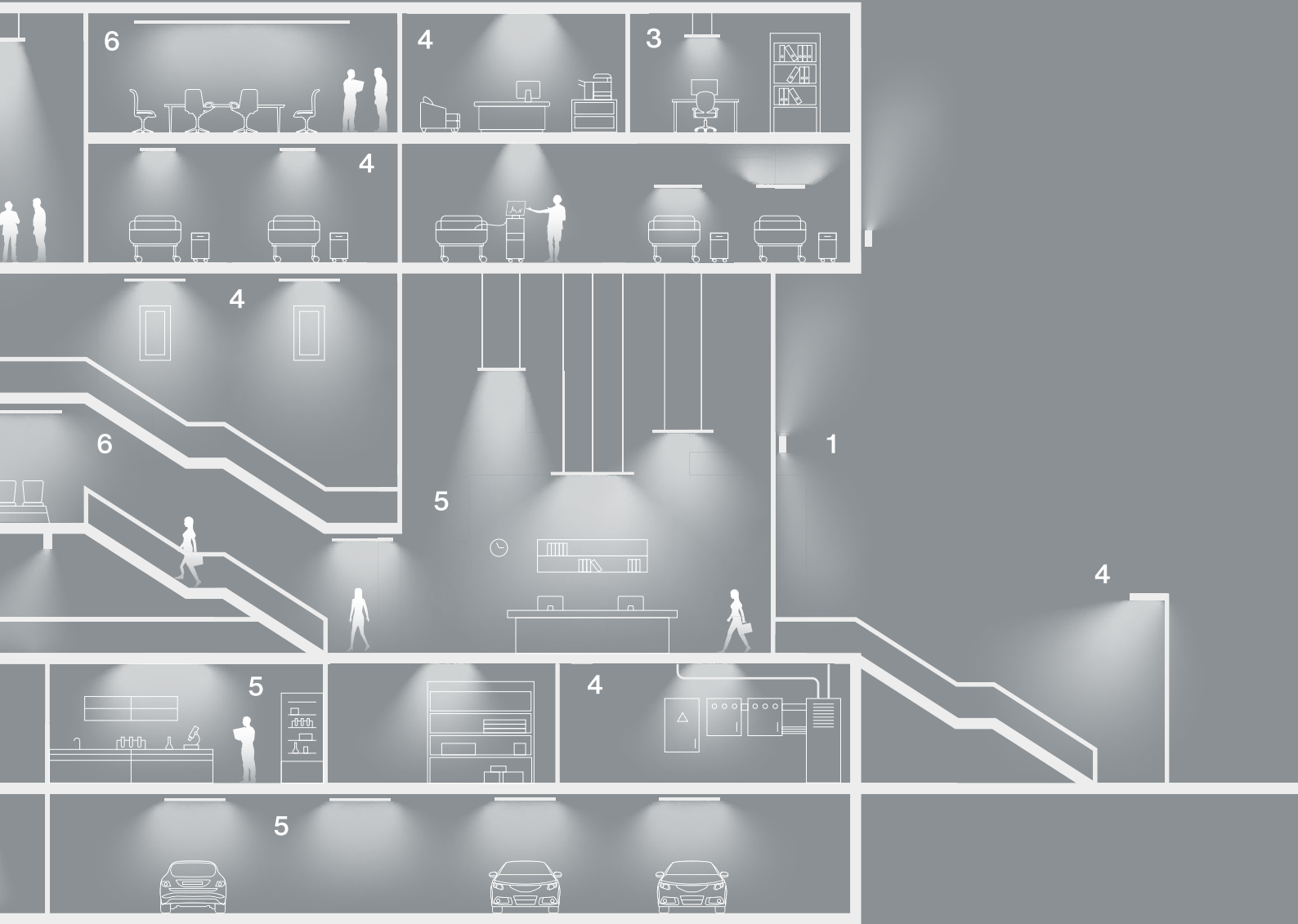

1. supernarrow
up to 15°



2. narrow
15 - 35°



3. medium
35 - 60°

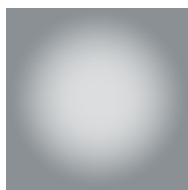

4. flood
60 - 90°

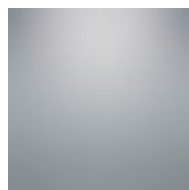

5. wideflood
90 - 120°

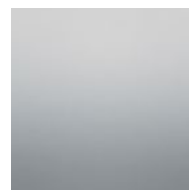

6. superflood
more than 120°



1. Optics SH



2. Raster SH



3. SHM

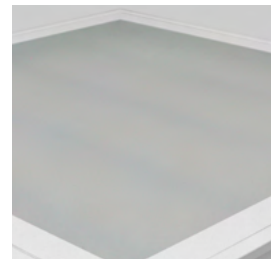

4. SHMR

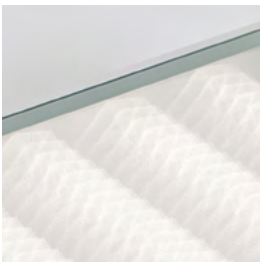

5. Micro-PRM SH, UGR<19



6. Micro-PRM SHR, UGR<19



7. SLM

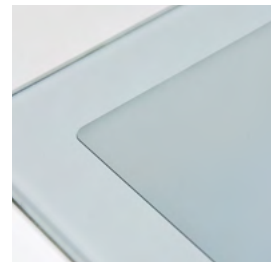

8. SLMR



9. Micro-PRM SL, UGR<19



10. Micro-PRM SLR, UGR<19



11. PLX



12. Micro-PRM, UGR<19



13. Micro-PRM PLX-T,
UGR<19



14. PC (polycarbonate)



Rubin Clean Corner



A variety of options

It is possible to personalise the product by choosing between different variations of diffusers and optical systems. Optics systems based on lenses - guarantee many different light distributions.

Outer material	Properties		Luxiona's diffusers	Construction	Characteristics
Protective glass	Standard	Transparent	1. Optics SH	Tempered glass with lenses	Impact proof and chemical resistant. Varied light distributions.
		Transparent	2. Raster SH	Tempered glass with anti-glare louver	Impact proof and chemical resistant. For low glare applications.
		Matt	3. SHM	Tempered matt glass	Impact proof and chemical resistant. Diffused light
	Antireflective properties	Matt	4. SHMR	Tempered anti-reflective matt glass	Impact proof and chemical resistant. Antireflective for laser use areas. Diffused light
	With PMMA optical diffuser	Micro-prismatic	5. Micro-PRM SH	Micro-prismatic diffuser with tempered glass	Impact proof and chemical resistant for low glare applications
Safety glass	Standard	Matt	7. SLM	Laminated matt glass	Shatterproof and chemical resistant. Diffused light
		Matt	8. SLMR	Laminated anti-reflective matt glass	Shatterproof and chemical resistant. Antireflective for laser use areas. Diffused light
	With PMMA optical diffuser	Micro-prismatic	9. Micro-PRM SL	Micro-prismatic diffuser with laminated glass	Shatterproof and chemical resistant for low glare applications
	With PMMA optical diffuser	Micro-prismatic	10. Micro-PRM SLR	Micro-prismatic diffuser with laminated anti-reflective glass	Shatterproof and chemical resistant for low glare applications. Antireflective for laser use areas.
PMMA diffuser	Standard	Opal	11. PLX	PMMA opal diffuser	Plastic diffuser for general applications
	Optical diffuser	Micro-prismatic	12. Micro-PRM	Micro-prismatic diffuser	Plastic diffuser for low glare applications
		Micro-prismatic	13. Micro-PRM PLX-T	Micro-prismatic and PMMA transparent diffuser	Plastic diffuser for low glare applications
PC diffuser	Standard	Opal	14. PC	PC opal diffuser	Impact proof plastic transparent diffuser for general applications

Other diffuser combinations (PLX/PC/PCT/PRM/ML) + protecting glass (SH/SL/SR/SLR) under request. Consult us.



Customised gear

Smart lighting opens up a new range of possibilities. It enhances comfort and introduces flexibility enabling significant energy savings. By tuning the tone and brightness of light at a different times of day it's easier to keep everyone focused and alert, especially during long hours while carrying out complicated surgeries or during work in precision engineering and microelectronics industry requiring a high level of focus. Other times it allows to dim or turn off the lighting in the parts of building with less traffic. The luminaires can be also equipped with an emergency module that provides the luminaire with the possibility of emergency operation.

Casambi

Casambi is a smart lighting system, that allows a mobile device to communicate directly with a luminaire and luminaires to communicate with each other. It uses a low-power radio communication technology that's built into every modern smartphone, laptop, and tablet. Which makes them ideal tools for controlling lighting, colour, or setting up scenes. It helps bring flexibility and personalisation to designs. By using sensors built into fittings it's also possible to respond to different circumstances and share the data in the cloud.

DALI

DALI is a protocol that enables efficient communication. It works between individual luminaires or groups of luminaires and a control system. It integrates and communicates with other system components such as motion detectors and light sensors, allowing for quick and easy reconfiguration. By use of intelligent LED lighting control, it's possible to save costs associated with lighting, by reducing light intensity in certain working areas which are not currently used or have sufficient daylight.

CASAMBI



 **Bluetooth™**



CLO ready



Smart lighting



Aesthetic

Lighting adjusted to a specific clean room and it's specific needs, either by modifying light levels or selecting different shades of light.



Emotional

Changes in the hue of light provoke relaxation or stimulation reactions in living beings and in people's spirits.



Big Data

Connected lighting allows us to use technology (IoT) to collect, manage and analyze information: space utility, temperature and humidity data, pressure, noise, light levels, air composition, traceability of space.



Scalability

The new elements of connected lighting have plug & play technology, which allows you to expand the network without having to reconfigure it again.



Connectivity

Through the use of wireless systems for the wireless operation of many elements, simplifying the complexity of the system installation. In addition, Smart Lighting systems can be managed and controlled centrally.



Scenographic

The new control systems allow the generation of personalised scenes for each user.



Comfort

Visual comfort and an optimal user experience in every space.



Security and maintenance

Integration of emergency lamps with general lighting in a single system, of: monitoring and testing of lighting in real time, simplify management and save installation costs.



Energy efficiency

Sustainability in energy saving as a most important parameter in the design of our architectural environments.



Flexibility

It allows adjusting the lighting of the place according to the needs required by the activity carried out, the contribution of natural light and the presence of activity through the use of light level and presence sensors.

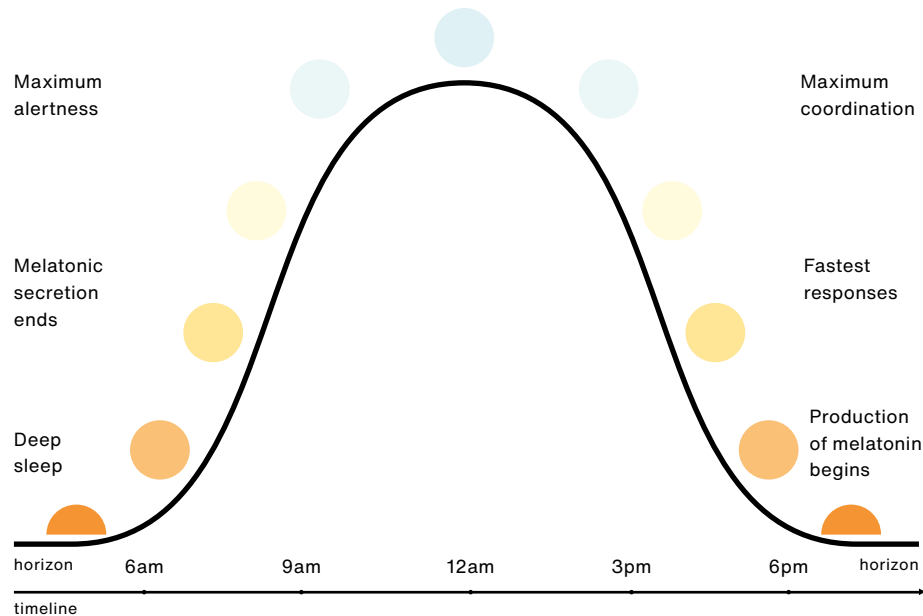

Patient Centric Lighting

A perfect light for increased focus, wellbeing and recovery.

Lighting supports physical and emotional well-being with groundbreaking concepts for Human Centric Lighting (HCL), which focuses on people and the optimal light for their needs. For example, it brings the natural course of daylight and its biological effects on patients, medical staff, industry workers, and every other person staying or working in indoor areas with artificial light. This is achieved by using artificial light with the right brightness and colour temperature to supplement the daylight. The interplay of light and room climate creates an atmosphere that has a positive impact on the well-being and recovery of patients, especially the long-term hospital patients. The HCL approach focuses on supporting the body's circadian rhythm, a process that lasts approximately 24 hours. An effective lighting solution taking into consideration the HCL approach uses the colour and the brightness of the light to imitate the changes natural light undergoes throughout the day. It allows us to define levels of visual

comfort and create the correct relationship between lighting levels and colour temperature better suited to our activities, with the help of technologies such as Tunable White.

The greatest benefits of the HCL system are seen in the healthcare sector. Patients are exposed to artificial light for long periods of time. It is important to ensure a natural daytime rhythm, not only to improve wellbeing, but also for faster recovery.

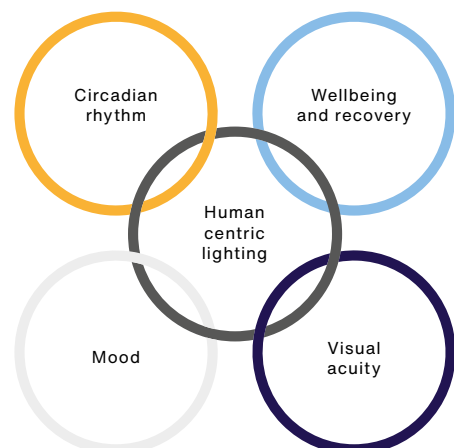

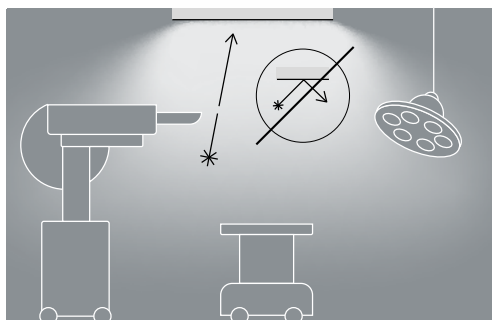

Protection from laser beam reflection

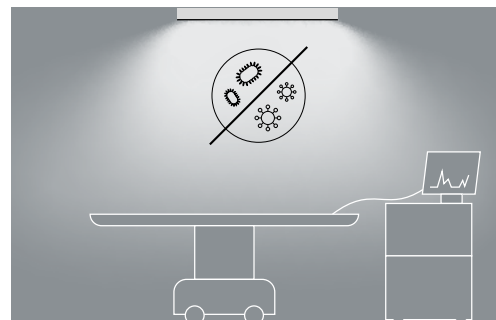

Antibacterial coating preventing from micro-organisms



Special coatings

Anti-reflective coating

Special, anti-reflective coating minimizes the reflection of the laser beam. This kind of finishing is used particularly for operating theaters where procedures are performed using laser light beams. To receive this glass property, it is subjected to a special chemical process, that modifies its morphology and chemical composition. It results in a changed layer of glass in the nanometer range giving it unique properties that increase light transmission and reduce reflection losses. Thanks to interfering with the glass structure, the obtained parameters are durable compared to standard coatings, which are deposited on the glass surface. The glass is practically invisible and has a greater (by about 5-10%) light transmittance when using the same LED modules and power supplies. All our Clean ISO luminaires (medical devices) have an anti-reflective coating, in two versions: matt laminated glass with anti-reflective coating - SLMR, or matt tempered glass with anti-reflective coating - SHMR. Clean Standard and Clean Class luminaires can also be fitted with an anti-reflective coated diffuser in customised versions.

Antibacterial coating

In luminaires dedicated to rooms where clean conditions are essential (particularly in demanding healthcare spaces: operating rooms, intensive care units, or sterile rooms in various industries), it is beneficial to make luminaires with antibacterial coatings. Those special paints contain silver ions that protect against the growth of bacteria and mold on surfaces. Silver as a natural antibiotic destroys about 650 types of pathogenic bacteria. Ions stick to bacterial cell membranes, preventing the secretion of enzymes and neutralizing them. That's why silver is widely used in the production of medical equipment and other equipment intended for use in buildings where a high degree of cleanliness is significant. Installation of luminaires with an antibacterial coating inhibiting the growth of bacteria effectively contributes to the improvement of clean conditions. All our Clean ISO and Clean Class luminaires are equipped with an antimicrobial coating. UV-C luminaires can be fitted with an antimicrobial coating on request.



Mazovian Centre for Treatment of Lung Diseases and Tuberculosis – children's ward, Otwock. Poland



Imprints for Children Wards

With a variety of colours available in our offer designers gain real freedom in bringing to life colourful projects intended for medical rooms designed for children.

The possibility of painting some of our luminaires according to the RAL palette is another step toward limitless creativity. While the white luminaire can be easily integrated with the ceiling or walls, sometimes it's necessary to create a visual diversity between them. The vivid colour of a luminaire can become an eye-catching highlight or brighten up a children's ward and help young patients feel more comfortable in such as stressful environment as a hospital.

Customisable dimensions

The products from our offer can be personalised in terms of length, width or diameter, giving you limitless possibilities and allowing you to match the product perfectly to the space.





Ospedali del Veneto Vidas, Milano. Italy



Ospedali del Veneto Vidas, Milano. Italy

From extreme to standard clean requirements

After years of ongoing development, our experts made perfect use of the experience drawn from clean-room projects and combined it with the very latest lighting technology. It results in a complex solution with a three-level luminaire concept for clean rooms: Clean ISO luminaires, Clean Class luminaires, and Standard Clean luminaires. It is based on PN-EN ISO 14644 -1: 2005 norm for Clean rooms and other controlled environments with defined pollution levels related to the particles size. A wide selection of products divided into three separate categories answers to all the needs of different clean environments as well as particular visual tasks in each and every clean sector.

The Standard specifies lighting requirements for indoor workplaces where the needs of visual comfort and visual performance of normally sighted people meet. The document contains requirements for all typical visual tasks, including workplaces equipped with screen monitors. The requirements specify both quantitative values and qualitative characteristics of lighting. The Standard additionally provides recommendations for good lighting practice.

EN 12464-1 does not recommend specific solutions or limit the freedom of designers to use new techniques or innovative lighting devices. Lighting can be produced by daylight, artificial light or a combination of both.

In order to reach such levels of illuminance at bed level, high lumen outputs shall be used. Luxiona provides up to 11000 lumens for a 60x60 fittings and 18000 lumens for 120x30cm fittings.

Lighting requirements in EN 12464-1

Type of task/ activity area	E_m lx		U_0	R_a	R_{UGL}	$E_{m,z}$ lx	$E_{m,wall}$ lx	$E_{m,ceiling}$ lx	Specific requirements
	Required	Modified							
General lighting	500	750	0,60	90	19	150	150	100	$4000 K \leq T_{cp} \leq 5000K$
Examination and treatment	1000	1500	0,70	90	19	150	150	100	$4000 K \leq T_{cp} \leq 5000K$



ISO
13485

Clean ISO luminaires (Medical device)

Light for health

For the health sector, the luminaires must have not only the highest cleanliness level but also provide excellent lighting conditions to help perform the most difficult tasks, especially when the concentration of doctors and medical staff is a key to successful medical procedures. For the operating theatres, luminaires with the highest luminous intensities are recommended. The blue light spectrum helps stay focused and alert and helps to kill bacteria. Luminaires with a stronger green light spectrum are perfect to calm down patients and reduce the feeling of pain.

Clean ISO luminaires are recommended for:
 Operating theaters. Intensive care rooms / ICU. Rooms that are intended for laparoscopic and endoscopic procedures.
 Recovery rooms after surgery Dermatology offices.
 Blood collection points.



Agat Clean ISO LED
CRI95



Agat Clean ISO
No Frame LED
CRI95



Rubin Clean ISO
LED CRI95



Rubin Clean ISO No
Frame LED CRI95

Product submitted and registered in the Office for Registration of Medicinal Products, Medical Devices and Biocidal Products.

Compatible with basic requirements defined in directives of European Union: Directive of the Council 93/42/EEC (MDD) and the Directive of European Parliament and the Council 2007/47/EC.

Fulfils the requirements defined in the bill of February 3rd 2017 about Medical Products.

Tested and compatible with European norm PN-EN 60601-1, PN-EN 60601-1-2 (Medical electric devices-overall safety requirements and basic technical requirements).



ISO
14644

Clean Class luminaires

Light for industry

Design for clean luminaires intended for the industry provides light for demanding visual tasks in pharmaceutical and chemical production facilities, laboratories, the food industry, and other industrial cleanrooms. Our luminaires have been developed under strict cleanliness principles, meet all legal requirements for selected cleanliness classes, and are highly efficient. The result is effective lighting, with the simplified body design resistant to dust particles, moisture, and to disinfectants used in many clean rooms.

Airborne Particulate Cleanliness Classes

Depending on the requirements, the cleanliness of the clean rooms is divided into classes in which the amount and size of the pollution per cubic metre of the atmosphere are defined. The table shows the number of particles per m³ of air permissible in a room of a given ISO cleanliness class. It also includes the particle size expressed in micrometres in accordance with EN ISO 14644. For example, in an ISO Class 3 room, 35 particles per m³ of 0.5 microns are allowed.

Class	Number of Particles per Cubic Metre by Micrometre Size					
	0.1 micron	0.2 micron	0.3 micron	0.5 micron	1 micron	5 microns
R9						
ISO 3	1000	237	102	35		
ISO 4	10000	2370	1020	352	83	
ISO 5	10000	23700	10200	3520	832	29
ISO 6	100000	237000	102000	35200	8320	293
ISO 7				352000	83200	2930
ISO 8				3520000	832000	29300
ISO 9				35200000	8320000	293000

Class 3-4

Pharmaceutical production: rooms used for tablets production, weighing, filling, making aseptic connections and film coatings; Electronic Industry: Displays production, semiconductors production (electrotechnics).

Class 5-6

Sterilizations, plaster rooms within operating theatres, „Clean” corridors of operating theatres; Chemical industry: production of household chemicals and cosmetics; Research laboratories (with laminar chambers) e.g. microbiological; precision production (microelectronics and microoptics), medical equipment production, computer components production.

Class 7-8-9

Chemical industry, plastics - oil industry, glass industry, precision castings; Food industry-Preparation rooms, food production and initial packaging processes; Solutions and film coatings preparation rooms; After wash components procedure, later filling and film coating; Clean room production surroundings / clean production.

Class 3-4



Agat Clean Class
3-4 LED



Agat Clean Class
3-4 No Frame LED



Rubin Clean Class
3-4 LED



Rubin Clean Class
3-4 No Frame LED

Class 5-6



Agat Clean Class
5-6 LED



Agat Clean Class
5-6 No Frame LED



Rubin Clean Class
5-6 LED



Rubin Clean Class
5-6 No Frame LED

Class 7-8-9



Agat Clean Class
7-8-9 LED



Rubin Clean Class
7-8-9 LED



IP
65

Standard Clean luminaires

Light for improved care

The Standard version of the CLEAN luminaire focuses on basic clean-room requirements such as improved cleanliness level compared to traditional luminaires and ease of cleaning. The high-level tightness and protection from dust particles are combined with luminaires' effectiveness and ability to provide pleasant, uniform lighting.

Doctors and nurses stations/offices, maternity wards, ophthalmology and laryngology offices, delivery rooms, treatment rooms, dental offices, laboratories, decontamination rooms, inspection rooms.



Emergency Medical Service, Pruszcz Gdanski. Poland



The Dialysis Station and the Nephrology Department of the Provincial Hospital, Lomza. Poland



BHU Linemed Triangle LED



Agat Clean-Eco LED



Agat Clean LED



Agat Clean LED Smooth

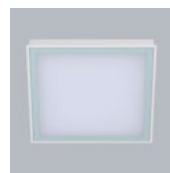

Agat Clean No Frame LED



Agat Clean Pos LED



Agat Clean Slight LED



Domino Clean Low UGR LED



Topaz ODG Clean AL LED



Topaz ODG Clean ST LED Smooth



Rubin Clean Corner



Rubin Clean LED



Rubin Clean LED Smooth



Rubin Clean No Frame LED



Agat Clean-Eco LED CRI95



Agat Clean LED CRI95



Agat Clean No Frame LED CRI95



Rubin Clean LED CRI95





Rubin Clean No Frame LED CRI95

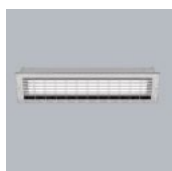

Agat Clean LED Tunable White

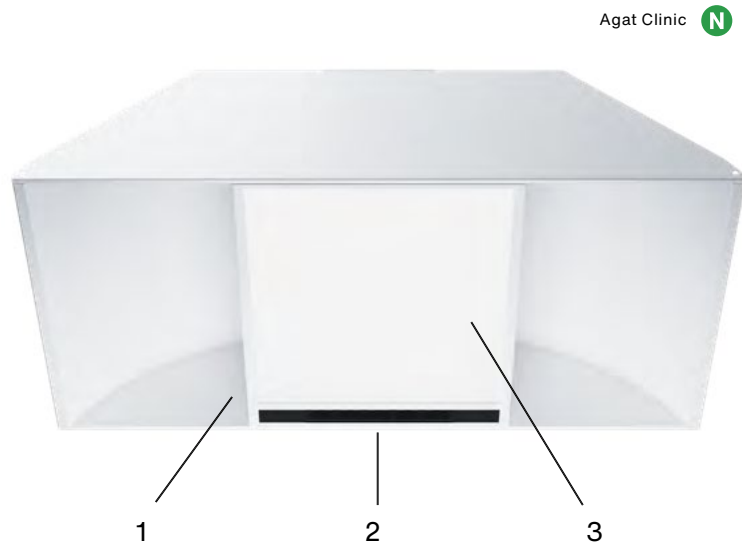

Rubin Clean Corner Inox LED

Agat Clinic 

CRI >80	60000h L80/B10	SDCM 3	3000 K
------------	-------------------	-----------	-----------

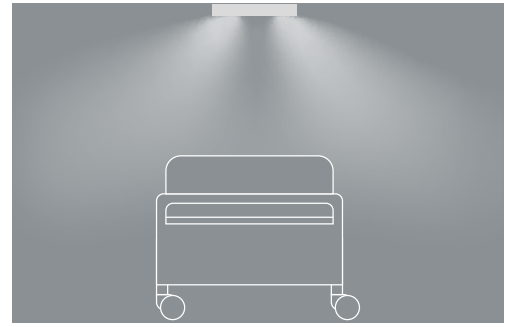

1. Soft light ambiance - 140°

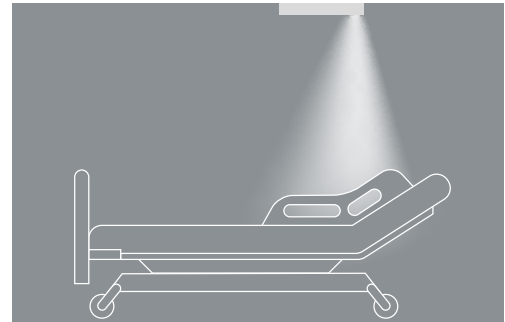

2. Reading light - 20°



3. Recognition light - 90°

New Agat Clinic for patient room

New luminaire especially created for use in health & care facilities. This innovative lighting ensures the comfort and safety of patients, providing them with as many as three different light distributions that answer to all their needs.

This modern luminaire is designed for modular suspended ceilings. With highly efficient LED panels Agat Clinic ensures top, energy-saving performance. The housing of the luminaire is made of steel sheet, powder coated in white. Equipped with three separate electrical circuits is adapted to the emission of as many as three different light distributions. The first mode is perfect for examining a patient. The main, direct light distribution is achieved with the use of two opal PMMA diffusers: micro prismatic and smooth with a luminous

flux of approx. 3300 lm.

The second, indirect light distribution, provides soft, relaxing, and very pleasant light. It is perfect for moments during the day when a patient is resting. In this mode, the luminaire provides 900 lm of luminous flux. The last distribution, with a strongly focused beam of light, makes sure to provide necessary light without disturbing other patients in the room, perfect for reading. Provided with an anti-glare raster and a luminous flux of about 700 lm.



BHU Linemed Triangle



Bed Head Unit

An efficient solution for patients room providing different kinds of comfortable lighting combined with power supply and emergency equipment.

BHU Linemed bedside panel, designed for installation in hospital rooms. A solution combining the functions of lighting, power supply, call system and ICT connections. The panel provides: general lighting of the room with reflected light, local lighting for examination and reading, night lighting, 230 V electric sockets, data

sockets, equipotential socket, light switch. Panel entirely made of aluminium profiles, powder-coated. Panel covered with antibacterial coating. The luminaire is made of PLX - opal PMMA. The luminaire is fitted with two 230 V electrical sockets and three key light switches.

UVC disinfection lighting

No bacteria, viruses, and fungi on the surface thanks to UV-disinfection luminaires. Those are one of the most effective devices capable of destroying the DNA or RNA of any exposed microorganisms. The technology using ultraviolet light is an effective, convenient, and cost-efficient method of disinfection, that does not require human labor. It is also environmentally friendly by minimising the use of chemical disinfectants.

Why does UV-C disinfect?

The UV-C radiation of a low pressure lamp consists of a single spectral line of radiation at 254 nm, which is located in the area of maximum germicidal effect of the UV-C: between the wavelengths of 250 and 270nm.

Thanks to the absorption of energy from UV-C radiation by ribonucleic acids and proteins the molecular structure of the microorganisms, meaning its DNA and RNA falls apart.

UV-C Germicidal effectiveness

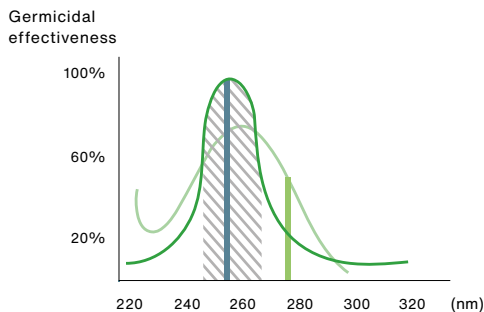

- Optimal germicidal effect curve
- DNA absorption curve
- ▨ Area of greatest germicidal effect of UV-C radiation in the 250-270nm wavelength range
- UV-C Low Pressure Radiation at 254nm
- UV-C LED radiation in a 280nm wavelength with very low germicidal effect

Molecular structure (DNA+RNA)

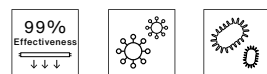
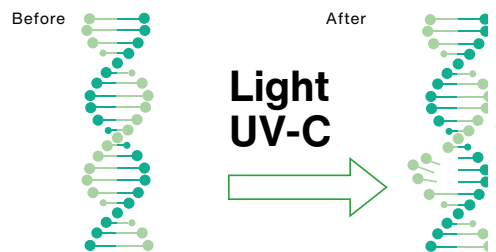

99.9% effectiveness against microorganisms

Why did we choose low-pressure radiation as the source?

Sources of low pressure UV-C radiation are more effective than LEDs in their germicidal effect and are currently the only source of light for applications in large spaces.

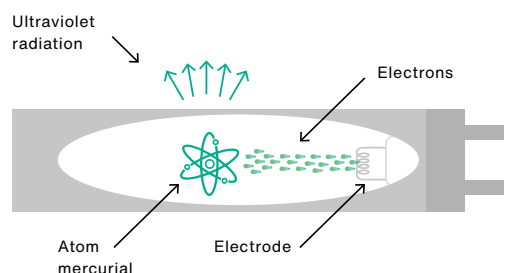

Disinfection by direct radiation

Air and surface disinfection by direct exposure to UV-C radiation.

The benefit of direct UV-C radiation is short time of disinfection and no need for room ventilation. It also eliminates unpleasant smells. While surfaces hidden from direct emission won't be disinfected, some materials

not resistant to UV-C radiation (eg. some types of polymers) may be affected by direct exposure to it. The luminaires are not safe to be present during the radiation.

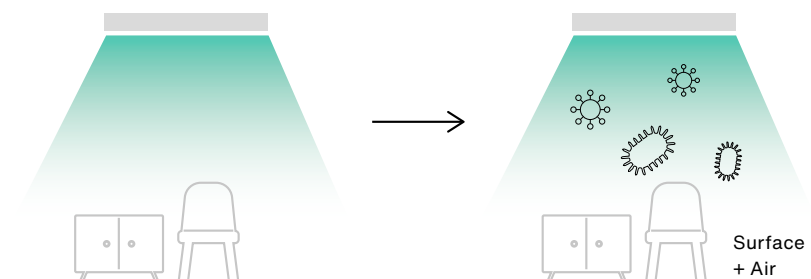

Living beings CANNOT be present during radiation.

UVC-FLOW air disinfection

Disinfection of the air through UV-C radiation, by air circulation inside the disinfection chamber.

Perfect for enclosed spaces. It takes longer than direct disinfection but as opposed it, it is safe to be present during the disinfection process. Technology removes bad odors and

is equipped with a low noise emission fan. Maintenance of this solution is easy thanks to its construction that keeps electrical components protected from dust and radiation.

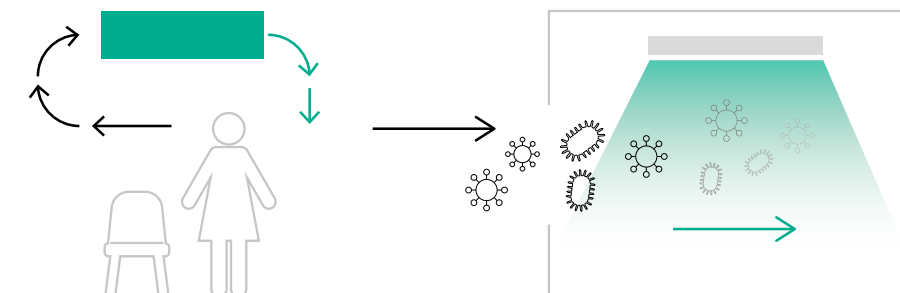

Disinfection by air circulation inside the disinfection chamber, safe for living beings.

Luxiona's disinfection luminaires

Everywhere that it's needed our UV-C radiation luminaires are effective disinfectants for air and surfaces, that help mitigate the risk of infections. With a wide selection of professional solutions, it's easy to find the perfect application to a chosen space.

Years of experience in lighting has led us to develop a wide range of UV-C disinfection luminaires, ideal for air and surfaces disinfection. This includes products both in direct disinfection technology and air flow technology, perfect for a wide range of applications in hospitals, medical facilities, schools, offices, factories or a public spaces used daily by a

large number of people. Made from high-quality, durable, UV-C resistant materials, our lighting solutions are created to provide dependable disinfection over the long lifetime. This is supported by our experience and highest standards manufacturing processes to guarantee the best quality.

Disinfection		Risk class	Body	Assembly	Optional			
Airstream UV-C	UV-C flow air	RG0	Steel sheet painted in white	Direct to the ceiling or on the wall (version W)	Motion sensor (turns off the luminaire in the case of detecting human presence)	Optional protective foil for T8 sources (glass protection in the case of fluorescent lamp cracks) version with bactericidal coating.	Mounting on a dedicated stand with wheels (possible montage in vertical and horizontal position)	Timer (optional). Monitoring the hours of lamp source operation.
				On the portable stand with wheels (version GM)				
Agaline UV-C	Direct UV-C	RG3		Direct to the ceiling or on the wall (version W)				
				On the portable stand with wheels (version GM)				
Oktan UV-C				On the wall (version Oktan W)		Version with bactericidal coating	Modes of operation: delayed shutdown, delayed switching on, cyclic shutdown, cyclical switching, delayed momentary switching on	
				On portable stand with wheels (version Oktan GM)				
Universal UV-C			Direct to the ceiling or in modular suspended ceiling or in plasterboard ceilings using a dedicated frame					



Airstream UV-C

Luminaire's sealed chamber uses air flow and allows the whole disinfection process to take place inside the housing, which makes it completely safe for everyone present in the disinfected rooms. The high-quality design protects from dust and is also covered with an antibacterial coating. All the components used in luminaire are UV-resistant and easy to maintain. Light sources contain a small amount of mercury - for the first 100 hours of operation, light sources emit a small amount of ozone. After using it, it is recommended to ventilate the room.



Agaline UV-C

Luxiona's bactericidal luminaire that effectively and irretrievably eliminates all viruses, bacteria and fungi. It's especially dedicated to disinfect rooms in hospitals, food factories, offices or a public spaces used daily by a large number of people. Luminaire has photobiological risk class (IEC/EN 62471) - RG3 (high risk), and can threat even during a short exposure. Light sources contain a small amount of mercury - for the first 100 hours of lamp operation, light sources emit a small amount of ozone. After using it, it is recommended to ventilate the room.



Oktan UV-C

Luminaire is perfect for use wherever mounting permanent luminaires is not possible. Its compact and portable standing case allows to place it anywhere: on table, shelves or floor. It can be also equipped with a portable stand. Luminaire with high photobiological risk class (IEC/EN 62471) - RG3, dangerous even during a short exposure. Light sources contain a small amount of mercury - for the first 100 hours of lamp operation, light sources emit a small amount of ozone. After using it, it is recommended to ventilate the room.



Universal UV-C

This bactericidal luminaire with simple design and easy installation is especially dedicated for compact fluorescent lamps TC-L, intended for disinfecting medical spaces and laboratories. The universal modular device allows for direct installation on the ceiling or in suspended modular ceilings. It's high photobiological risk class (IEC/EN 62471) - RG3 endangers our health even during a short exposure. It is not allowed to use them together with general lighting.



ALVO® Ultra V-bot

Innovative and automated UV-C solution

ALVO® Ultra V-bot is a device for bio-decontamination using UV-C light, with proven technology to reduce biological contamination. The technology used in the ALVO® Ultra V-bot monitors and adjusts the disinfection process to ensure the most optimal results in reducing surface and air pollution.

ALVO Ultra® V-bot is equipped with sensors and scanners which create a virtual map of the scanned area. After the room has been mapped, the operator indicates in the user application, the zones (points) the robot should reach in order to perform decontamination. The disinfection process is activated by the operator remotely, from a tablet, after he has safely left the room (Wi-Fi communication). Thanks to the safety system and autonomous navigation, the ALVO® Ultra V-bot avoids with any equipment it would meet on the way and moves safely around the scanned environment. Compared to manual robots, ALVO® Ultra V-bot performs a repeatable, precise procedure that has been programmed.

The quality of the process is maintained at the same level and monitored each time. The direct medical cost related to Healthcare-Associated Infections (HAIs) in US hospitals exceeds \$10 billion annually. ALVO® Ultra V-bot significantly lowers the risk of dangerous, preventable infections transmitted by contaminated surfaces. This way saving hospitals from vital costs. Eradicating dangerous pathogens from the environment will be required not only in hospitals in the 'new normal'. ALVO® Ultra V-bot delivers excellent outcomes in all vital public spaces: concert halls, schools, production plants, sports centres, shopping malls, laboratories etc.



Hospital lighting solutions for every space

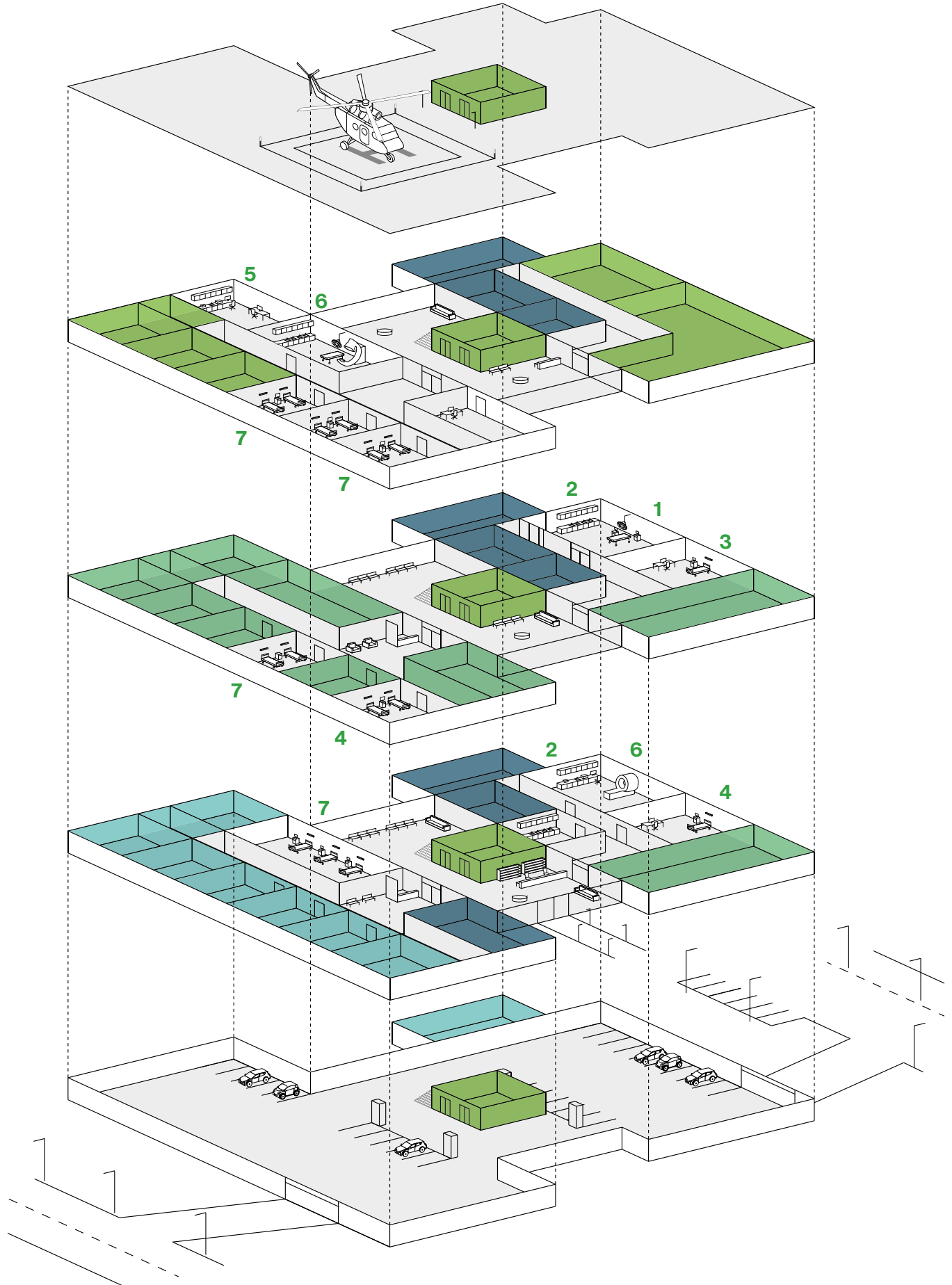

1 Operating theatres - surgery rooms



2 Surroundings of operating theatres (clean corridors)



3 Intensive care rooms (ICU)



4 Post-surgery recovery rooms



5 Blood extraction rooms



6 Laparoscopic & Endoscopic procedure rooms



7 Patient rooms



* Consult availability date
 N New product

Hospital lighting solutions for every space - continuation

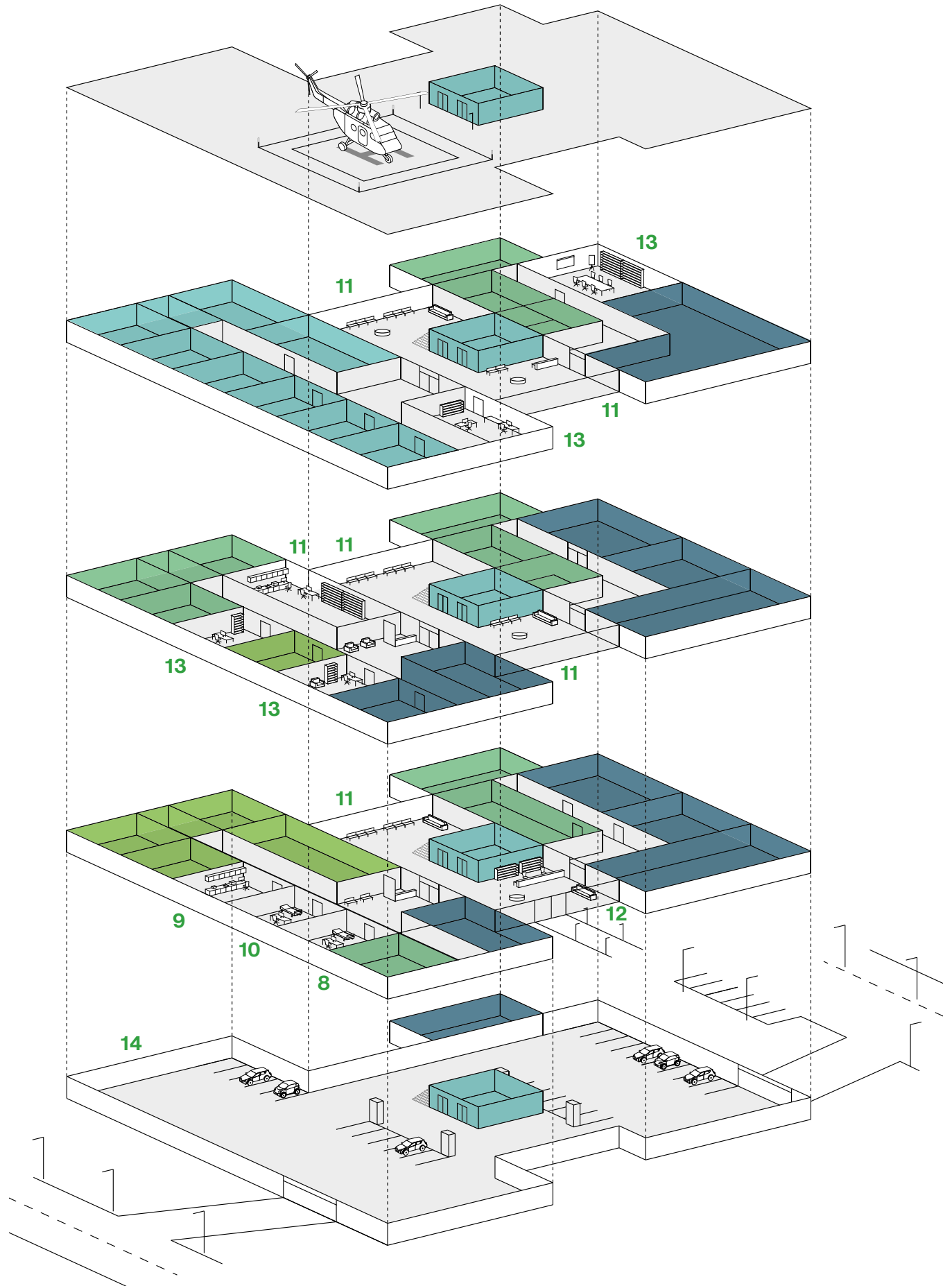

8 Consultancy & Doctors rooms

9 Laboratories

10 Dermatology & Dental offices

11 Common areas: corridors, waiting areas

12 Receptions

13 Doctors common offices

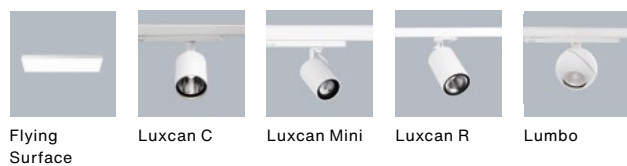
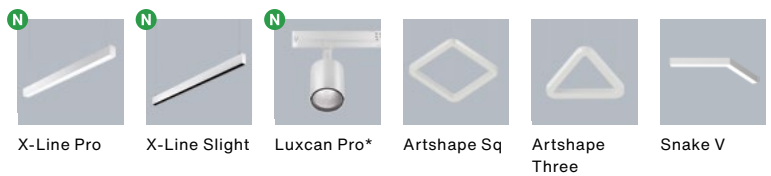
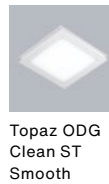

Clean factory lighting solutions for every space

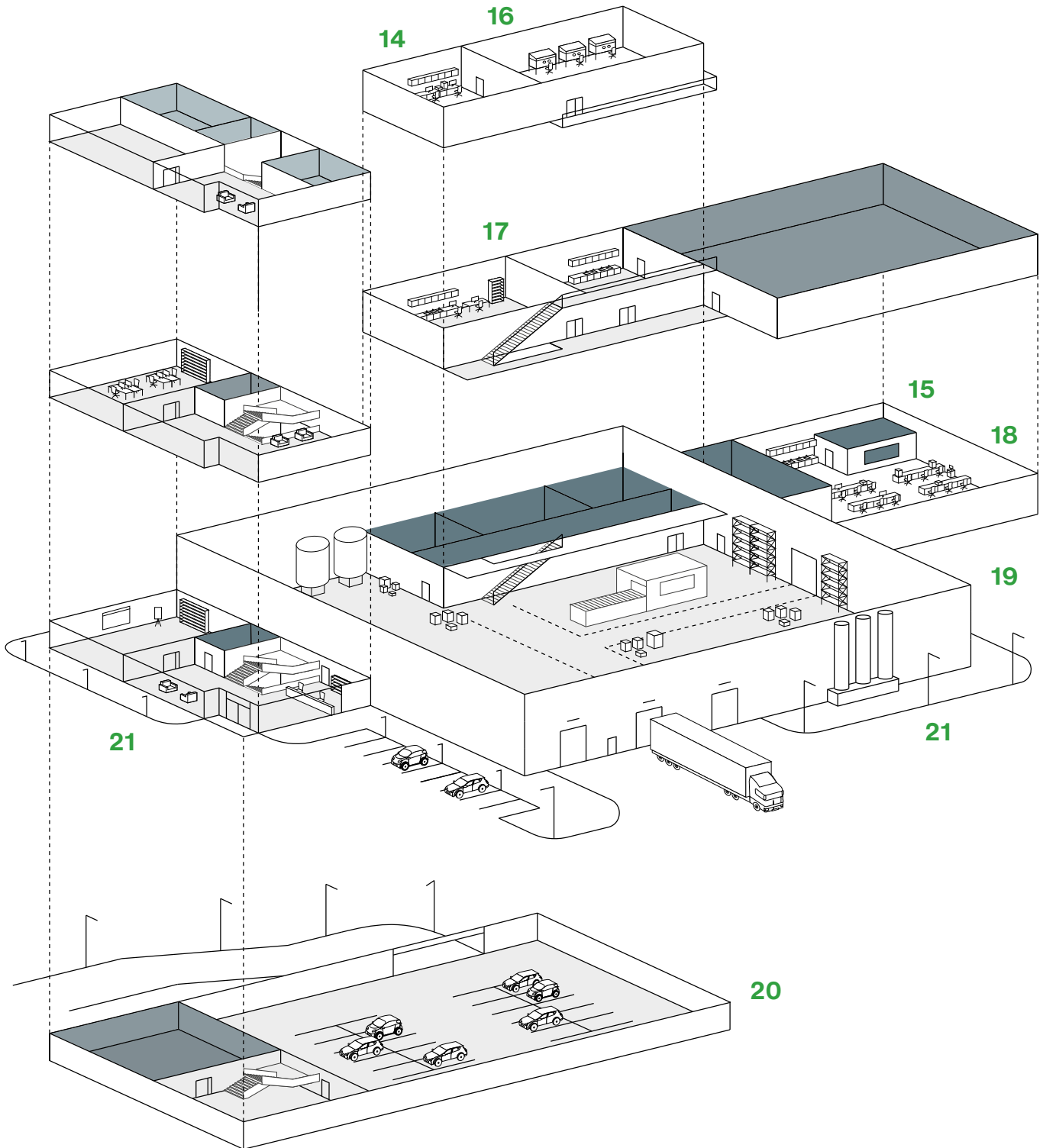

14 Research laboratory & Pharmaceutical laboratory



15 Clean rooms



16 Research laboratories with laminar chambers



17 Research laboratories without laminar chambers



18 Precision production



19 Food industry



20 Underground car parks



21 Outdoors: gardens, car parks

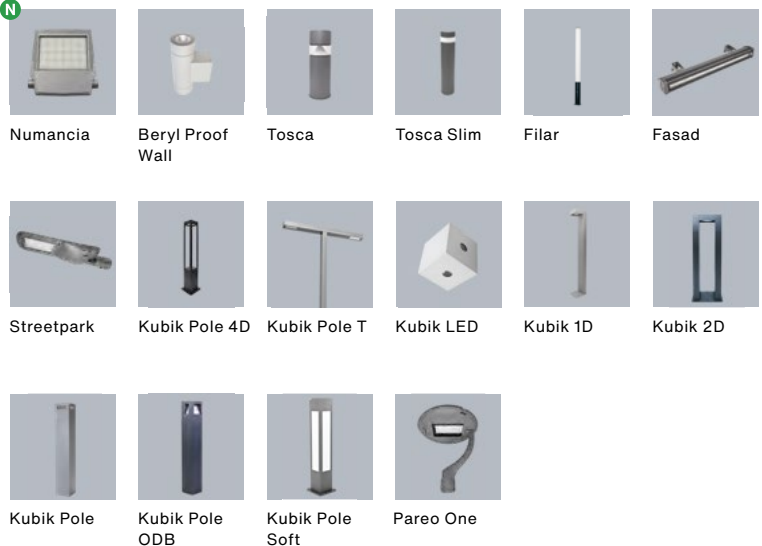

- 
- Operating theatres - surgery rooms**
 - Surroundings of operating theatres (clean corridors)**
 - Intensive care rooms (ICU)**
 - Post-surgery recovery rooms**
 - Blood extraction rooms**
 - Laparoscopic & Endoscopic procedure rooms**

Patient rooms

Consultancy & Doctors rooms

Laboratories

Dermatology & Dental offices

Common areas: corridors, waiting areas

Receptions

Doctors common offices

Research laboratory & Pharmaceutical laboratory

Clean rooms

Research laboratories with laminar chambers

Research laboratories without laminar chambers

Precision production

Food industry

Underground car parks

Outdoors: gardens, car parks

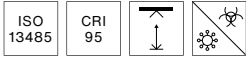

Agat Clean ISO CRI 95

Efficient luminaire made of steel sheet with optical systems and diffusers mounted in aluminium frame. Perfect for module suspended ceilings.

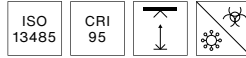

Agat Clean ISO No Frame CRI95

Perfect for demanding conditions excluding any contamination. Luminaire without a frame nor visible elements joining diffuser and luminaire's body.

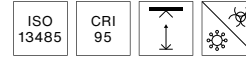

Rubin Clean ISO CRI 95

Highly efficient surface mounted luminaire made from steel sheet with diffusers and optical systems placed in aluminium frame.

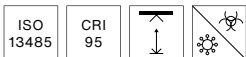

Rubin Clean ISO No Frame CRI95

Highest protection from contamination combined with efficient LED panels. Luminaire without aluminium frame.

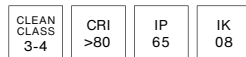

Agat Clean Class 3-4

Designed to module, gypsum and cardboard suspended ceilings. Combines a comfortable lighting with high performance.

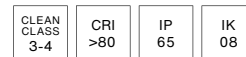

Agat Clean Class 3-4 No Frame

The luminaire is intended for clean rooms with an increased ISO 3-4 cleanliness class. Designed for suspended modular ceilings, equipped with highly efficient LED panels. Available with a wide range of diffusers.

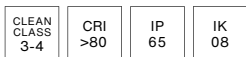

Rubin Clean Class 3-4

Comfortable lighting and efficiency thanks to modern LED panels. Luminaire with diffusers and optical systems placed in aluminium frame.

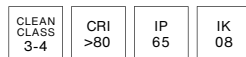

Rubin Clean Class 3-4 No Frame

Perfect solution for clean rooms that excludes any unwanted contamination. Luminaire thanks to lack of aluminium frame.

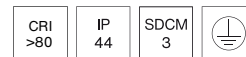

Laminar LED

Streamlined, oval shape that makes it suitable for rooms with laminar flow ventilation. The air flowing around the luminaire is less susceptible to mechanical resistance. LED modules with color temperature 4000 K or with monochromatic yellow light.





Non-Invasive Medicine Centre, The University Clinical Centre, Gdansk. Poland





- Operating theatres - surgery rooms
- Surroundings of operating theatres (clean corridors)
- Intensive care rooms (ICU)
- Post-surgery recovery rooms
- Blood extraction rooms
- Laparoscopic & Endoscopic procedure rooms

Patient rooms

- Consultancy & Doctors rooms
- Laboratories
- Dermatology & Dental offices
- Common areas: corridors, waiting areas
- Receptions
- Doctors common offices
- Research laboratory & Pharmaceutical laboratory
- Clean rooms
- Research laboratories with laminar chambers
- Research laboratories without laminar chambers
- Precision production
- Food industry
- Underground car parks
- Outdoors: gardens, car parks



CRI >80	IP 65	IK 04	SDCM 3
---------	-------	-------	--------

Agat Clinic N

New and innovative solution that ensures the comfort of patients, providing them with three different light distributions that answer all their needs.



CRI >80	IP 65	IP 40	IK 04
---------	-------	-------	-------

BHU Linemed Triangle

Modern BHU panel, indispensable in hospital rooms. Combines ambient lighting with a life saving equipment: a power supply, call system and ICT connections.

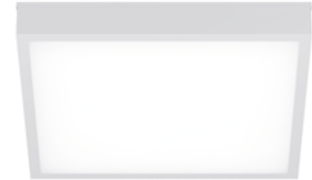

	CRI >80	IP 65	IK 08
--	---------	-------	-------

Agat Clean-Eco

Luminaire designed to module suspended ceilings. Luminaire body made from steel sheet. Diffusers permanently mounted, no aluminium frame.



	CRI >80	IP 65	IK 08
--	---------	-------	-------

Agat Clean

Luminaire designed to module and plasterboard suspended ceilings. Luminaire body made from steel sheet. Optical systems and diffusers mounted in an aluminium frame.



	CRI >80	IP 65	IK 08
--	---------	-------	-------

Agat Clean LED Smooth

Luminaire designed to module and plasterboard suspended ceilings. Luminaire body made from steel sheet. The product ensures a homogeneous distribution of light.



	CRI >80	IP 65	IK 08
--	---------	-------	-------

Agat Clean Pos

LED luminaire designed to module and plasterboard suspended ceilings. Luminary design prevents from dazzle effect.



	CRI >80	IP 65	IK 08
--	---------	-------	-------

Agat Clean Slight

Luminaire designed to module suspended ceilings. Light distribution made by using high performance lenses.



	CRI >80	IP 65	IK 08
--	---------	-------	-------

Agat Clean No Frame

Luminaire designed to module and plasterboard suspended ceilings. Luminaire body made from steel sheet. Lack of aluminium frame.



	CRI >80	IP 65	IK 08
--	---------	-------	-------

Agat Clean TW

Luminaire designed to module and plasterboard suspended ceilings. Luminaire body made from steel sheet. Tunable White LED sources.

* Consult availability date
N New product

- 
- Operating theatres - surgery rooms
 - Surroundings of operating theatres (clean corridors)
 - Intensive care rooms (ICU)
 - Post-surgery recovery rooms
 - Blood extraction rooms
 - Laparoscopic & Endoscopic procedure rooms

Patient rooms - continuation

- Consultancy & Doctors rooms
- Laboratories
- Dermatology & Dental offices
- Common areas: corridors, waiting areas
- Receptions
- Doctors common offices
- Research laboratory & Pharmaceutical laboratory
- Clean rooms
- Research laboratories with laminar chambers
- Research laboratories without laminar chambers
- Precision production
- Food industry
- Underground car parks
- Outdoors: gardens, car parks

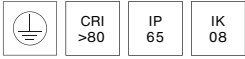

Rubín Clean

Surface mounted luminaire. Luminaire body made from steel sheet. Diffusers and optical systems in aluminium frame.

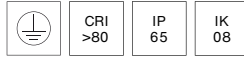

Rubín Clean Smooth

Surface mounted luminaire. Luminaire body made from steel sheet. The product ensures a homogeneous distribution of light.

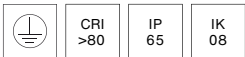

Rubín Clean No Frame

Luminaire perfect for clean rooms. Without frame or visible elements joining the diffuser with luminaire's body it provides contamination-free conditions.

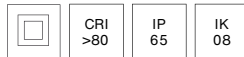

Domino Clean

Indispensable. Thanks to antiglare louvre it reduces glare and directs light precisely, providing with comfort and uniformity as well as welcoming general lighting.

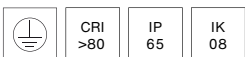

Topaz ODG Clean AI

Efficient light combined with easy maintenance. Special construction of luminaire allows opening it from the top and avoiding littering.

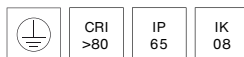

Topaz ODG Clean ST Smooth

Efficient luminaire with construction allowing opening it from the top and avoiding littering. Adapted to be walked on during maintenance.



Jolly Med, Warsaw, Poland





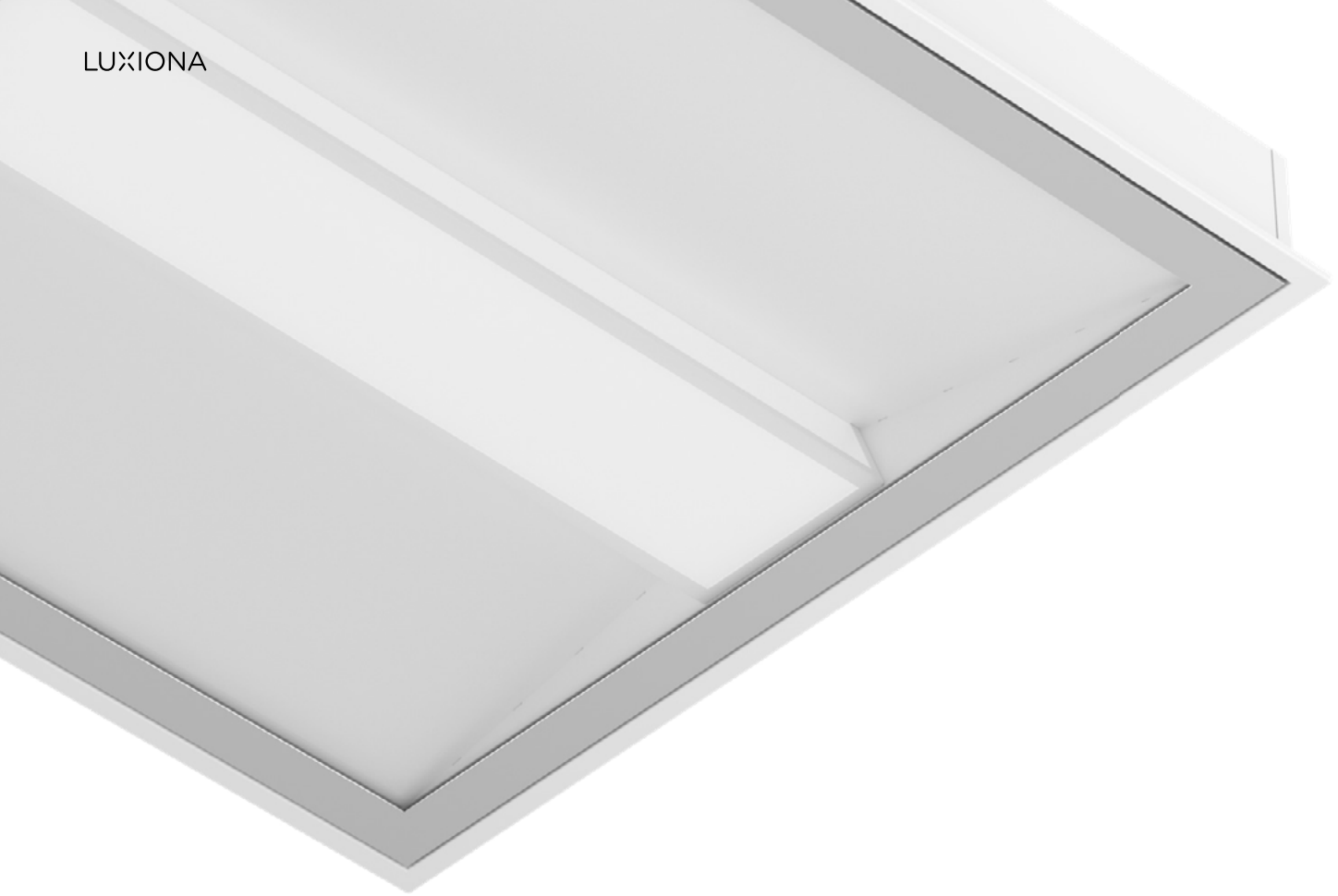

- Operating theatres - surgery rooms
- Surroundings of operating theatres (clean corridors)
- Intensive care rooms (ICU)
- Post-surgery recovery rooms
- Blood extraction rooms
- Laparoscopic & Endoscopic procedure rooms
- Patient rooms

Consultancy & Doctors rooms

Laboratories

Dermatology & Dental offices

- Common areas: corridors, waiting areas
- Receptions
- Doctors common offices
- Research laboratory & Pharmaceutical laboratory
- Clean rooms
- Research laboratories with laminar chambers
- Research laboratories without laminar chambers
- Precision production
- Food industry
- Underground car parks
- Outdoors: gardens, car parks

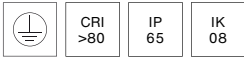
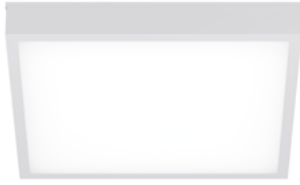

Agat Clean-Eco

Luminaire designed to module suspended ceilings. Luminaire body made from steel sheet. Diffusers permanently mounted, no aluminium frame.

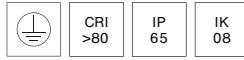

Agat Clean

Luminaire designed to module and plasterboard suspended ceilings. Luminaire body made from steel sheet. Optical systems and diffusers mounted in an aluminium frame.

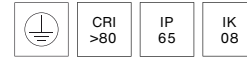

Agat Clean LED Smooth

Luminaire designed to module and plasterboard suspended ceilings. Luminaire body made from steel sheet. The product ensures a homogeneous distribution of light.

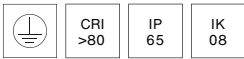
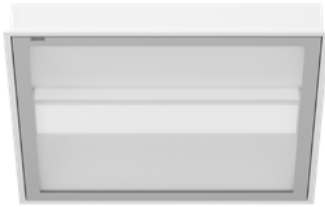

Agat Clean Pos

LED luminaire designed to module and plasterboard suspended ceilings. Luminary design prevents from dazzle effect.

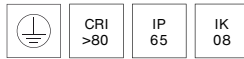

Agat Clean Slight

Luminaire designed to module suspended ceilings. Light distribution made by using high performance lenses.



Agat Clean No Frame

Luminaire designed to module and plasterboard suspended ceilings. Luminaire body made from steel sheet. Lack of aluminium frame.

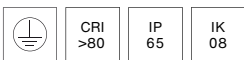
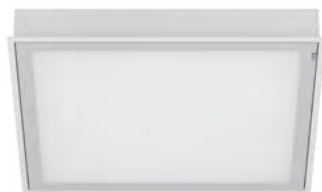

Agat Clean TW

Luminaire designed to module and plasterboard suspended ceilings. Tunable White LED sources ensure providing patients and medical staff with most comfortable lighting conditions.

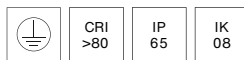

Rubin Clean

Surface mounted luminaire. Luminaire body made from steel sheet. Diffusers and optical systems in aluminium frame.

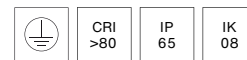

Rubin Clean Smooth

Surface mounted luminaire. Luminaire body made from steel sheet. The product ensures a homogeneous distribution of light.



Operating theatres - surgery rooms
Surroundings of operating theatres (clean corridors)
Intensive care rooms (ICU)
Post-surgery recovery rooms
Blood extraction rooms
Laparoscopic & Endoscopic procedure rooms
Patient rooms

Consultancy & Doctors rooms - continuation
Laboratories - continuation
Dermatology & Dental offices - continuation

Common areas: corridors, waiting areas
Receptions
Doctors common offices
Research laboratory & Pharmaceutical laboratory
Clean rooms
Research laboratories with laminar chambers
Research laboratories without laminar chambers
Precision production
Food industry
Underground car parks
Outdoors: gardens, car parks

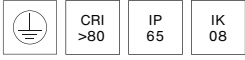

Rubin Clean No Frame

Luminare perfect for clean rooms. Without frame or visible elements joining the diffuser with luminaire's body it provides contamination-free conditions.

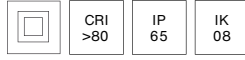

Domino Clean

Indispensable. Thanks to antiglare louvre it reduces glare and directs light precisely, providing comfort and uniformity as well as welcoming general lighting.

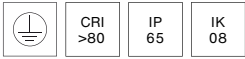

Topaz ODG Clean AI

Efficient light combined with easy maintenance. Special construction of luminaire allows opening it from the top and avoiding littering.

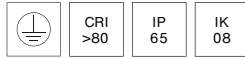

Topaz ODG Clean ST Smooth

Efficient luminaire with construction allowing opening it from the top and avoiding littering. Adapted to be walked on during maintenance.





Non-Invasive Medicine Centre, The University Clinical Centre, Gdansk. Poland





Operating theatres - surgery rooms
Surroundings of operating theatres (clean corridors)
Intensive care rooms (ICU)
Post-surgery recovery rooms
Blood extraction rooms
Laparoscopic & Endoscopic procedure rooms
Patient rooms
Consultancy & Doctors rooms
Laboratories
Dermatology & Dental offices

Common areas: corridors, waiting areas

Receptions
Doctors common offices
Research laboratory & Pharmaceutical laboratory
Clean rooms
Research laboratories with laminar chambers
Research laboratories without laminar chambers
Precision production
Food industry
Underground car parks
Outdoors: gardens, car parks



Agat Slim

Versatile lighting, designed to manage light and to create comfortable view indoors. Luminaire made from powder-coated steel sheet, perfect for creating long lines.



Snake V

Versatile lighting with a surprising twist. Luminaire combines comfortable lighting with creative appearance.



Beryl New K

A perfect union between minimalism, elegance and simple shape. The luminaire has the ability to adjust the optics in two planes (in the vertical axis by 359° and to the left and right 15°).



Beryl New O

Small, yet powerful. Luminaire perfectly aligned with a space's aesthetics, distinguished by high efficiency and minimum usage. Excellent heat dissipation and large luminous flux for its size.



Beryl Surface K

Downlight surface-mounted luminaire unrivaled in combining quality and energy efficiency. It has the ability to adjust the optics (in the vertical axis by 359° and to the left and right 15°).



Beryl Surface O

Efficient lighting to light up spaces with hardly noticeable effect on the environment and our comfort. Small visibility gives room for great visual ease for its users.



Patos O

Architectural lighting that embodies an irreproachable style and high quality. With a circular design and soft light it subtly enhances the space and makes it more welcoming.



Patos Line

Simple and elegant, designed for exceptional spaces that need individual character. Luminaire with a smooth or prismatic diffuser with exceptionally good light transmission.



Versatile

Small size customisable downlight that comes in different lighting sources and combinable structures. Creates minimalist general lighting systems.



European Specialised Medical Centres – Korfantowska Orthopaedics and Rehabilitation KORT Ltd., Korfantow. Poland





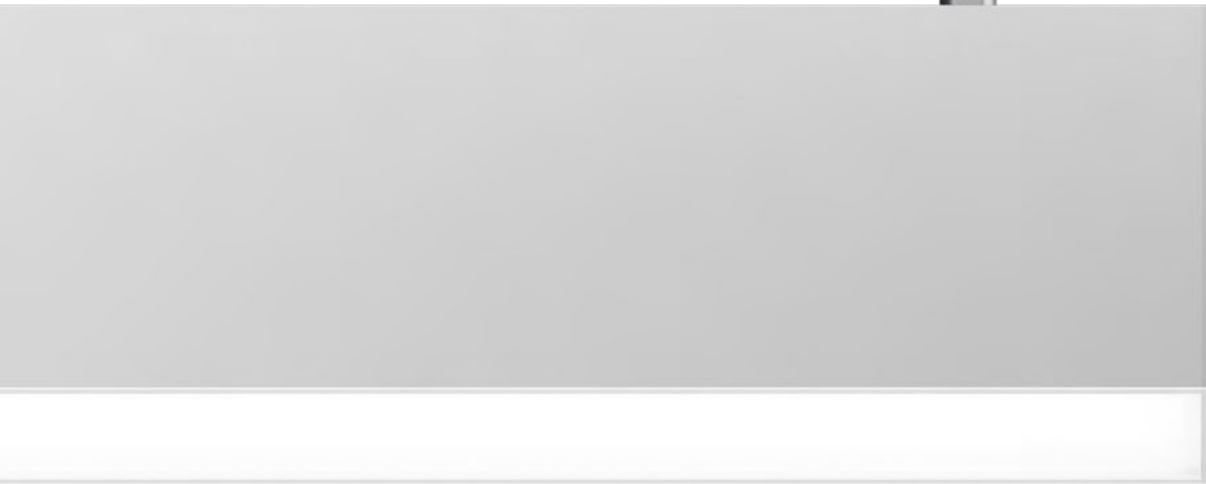

- Operating theatres - surgery rooms
- Surroundings of operating theatres (clean corridors)
- Intensive care rooms (ICU)
- Post-surgery recovery rooms
- Blood extraction rooms
- Laparoscopic & Endoscopic procedure rooms
- Patient rooms
- Consultancy & Doctors rooms
- Laboratories
- Dermatology & Dental offices
- Common areas: corridors, waiting areas

Receptions

- Doctors common offices
- Research laboratory & Pharmaceutical laboratory
- Clean rooms
- Research laboratories with laminar chambers
- Research laboratories without laminar chambers
- Precision production
- Food industry
- Underground car parks
- Outdoors: gardens, car parks



X-Line Pro N

A new, versatile product from the X-Line family, with a maximally simplified structure, without mounting plates or LED plates, distinguished by aluminium louvers with efficient LED sources.



X-Line Slight N

New luminaire with a classic and elegant line. An aluminium profile with a minimised width up to 34mm wide, and a diffuser recessed into the body and aesthetically flushed with the equipment.



Artshape Sq

A timeless design that provides creative lighting with the use of a square shape. With the possibility of painting according to RAL palette, it takes on diverse tasks in various spaces.



Artshape Three

Best way to evade boredom. Luminaire combines modern design and functionality with creating a variety of unconventional accents. Available in Full and Edge versions.



Snake V

Versatile lighting with a surprising twist. Luminaire combines comfortable lighting with creative appearance.

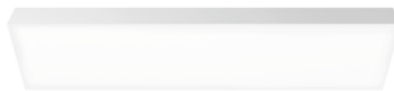

Flying Surface

A visionary eye-catcher. A proposal that arose from French designer **Jean Nouvel** and Troll's alliance. It gives the feeling of floating in space and provides even and balanced lighting.



- Operating theatres - surgery rooms
- Surroundings of operating theatres (clean corridors)
- Intensive care rooms (ICU)
- Post-surgery recovery rooms
- Blood extraction rooms
- Laparoscopic & Endoscopic procedure rooms
- Patient rooms
- Consultancy & Doctors rooms
- Laboratories
- Dermatology & Dental offices
- Common areas: corridors, waiting areas

Receptions - continuation

- Doctors common offices
- Research laboratory & Pharmaceutical laboratory
- Clean rooms
- Research laboratories with laminar chambers
- Research laboratories without laminar chambers
- Precision production
- Food industry
- Underground car parks
- Outdoors: gardens, car parks



Luxcan Pro* N

A new product for different applications. Various optics, based on lenses, provide a wide range of possibilities, from the narrow beam, indirect, to the wide beam. Available with the possibility of ordering a non-standard version.



Luxcan C

Most advanced LED light sources and variety of optics. Perfect as an accent lighting in places requiring distinction. Power supply placed in the adapter allows for a smaller size of the luminaire.



Luxcan Mini

Small but strong. A classic luminaire with a perfect beam of light. Its power supply remains hidden by the rail, which decreases the luminaire's size.



Luxcan R

A cylindrical projector that seamlessly fits in any room. It combines advanced LED sources with a variety of optics perfect as an accent lighting in spaces that need a nice touch.



Lumbo

Balance and harmony. Spherical reflector designed for avoiding the visual disproportion. Combines Premium White LED sources with high colour rendering index. 'Total Orientation System' allows it to rotate through 355° or tilt by 90°.

* Consult availability date
N New product

REJESTRACJA

- < CHIRURGIA NACZYNIOWA
- < CHIRURGIA OGÓLNA
- < CHIRURGIA ONKOLOGICZNA
- < CHIRURGIA PLASTYCZNA
- < CHIRURGIA RĘKI
- < ORTOPEDIA
- < OTOLARYNGOLOGIA

ODDZIAŁ





Polish Mother's Memorial Hospital Research Institute, Lodz. Poland



Gameta - Infertility Treatment Clinic, Kielce. Poland 73



- Operating theatres - surgery rooms
- Surroundings of operating theatres (clean corridors)
- Intensive care rooms (ICU)
- Post-surgery recovery rooms
- Blood extraction rooms
- Laparoscopic & Endoscopic procedure rooms
- Patient rooms
- Consultancy & Doctors rooms
- Laboratories
- Dermatology & Dental offices
- Common areas: corridors, waiting areas
- Receptions

Doctors common offices

- Research laboratory & Pharmaceutical laboratory
- Clean rooms
- Research laboratories with laminar chambers
- Research laboratories without laminar chambers
- Precision production
- Food industry
- Underground car parks
- Outdoors: gardens, car parks



X-Line Pro N

A new, versatile product from the X-Line family, with a maximally simplified structure, without mounting plates or LED plates, distinguished by aluminium louvers with efficient LED sources.



X-Line Slight N

New luminaire with a classic and elegant line. An aluminium profile with a minimised width up to 34mm wide, and a diffuser recessed into the body and aesthetically flushed with the equipment.



Agat Pos

Comfort without the dazzle effect. Luminaire designed to module and suspended ceilings with optical system made of white reflectors.



Agat Deco Smooth

Gentle and mellow light. Luminaire brings the depth of the space to life and provides a uniform light as well as practical and lasting solutions.



Snake V

Versatile lighting with a surprising twist. Luminaire combines comfortable lighting with high efficiency and creative appearance.



Europanel

Inconspicuous yet effective. Luminaire with efficient LED sources for a wide range of applications. A perfect solution that easily blends with its surroundings.



Domino

Indispensable. Thanks to antiglare louvre it reduces glare and directs light precisely, providing comfort and uniformity as well as welcoming general lighting.

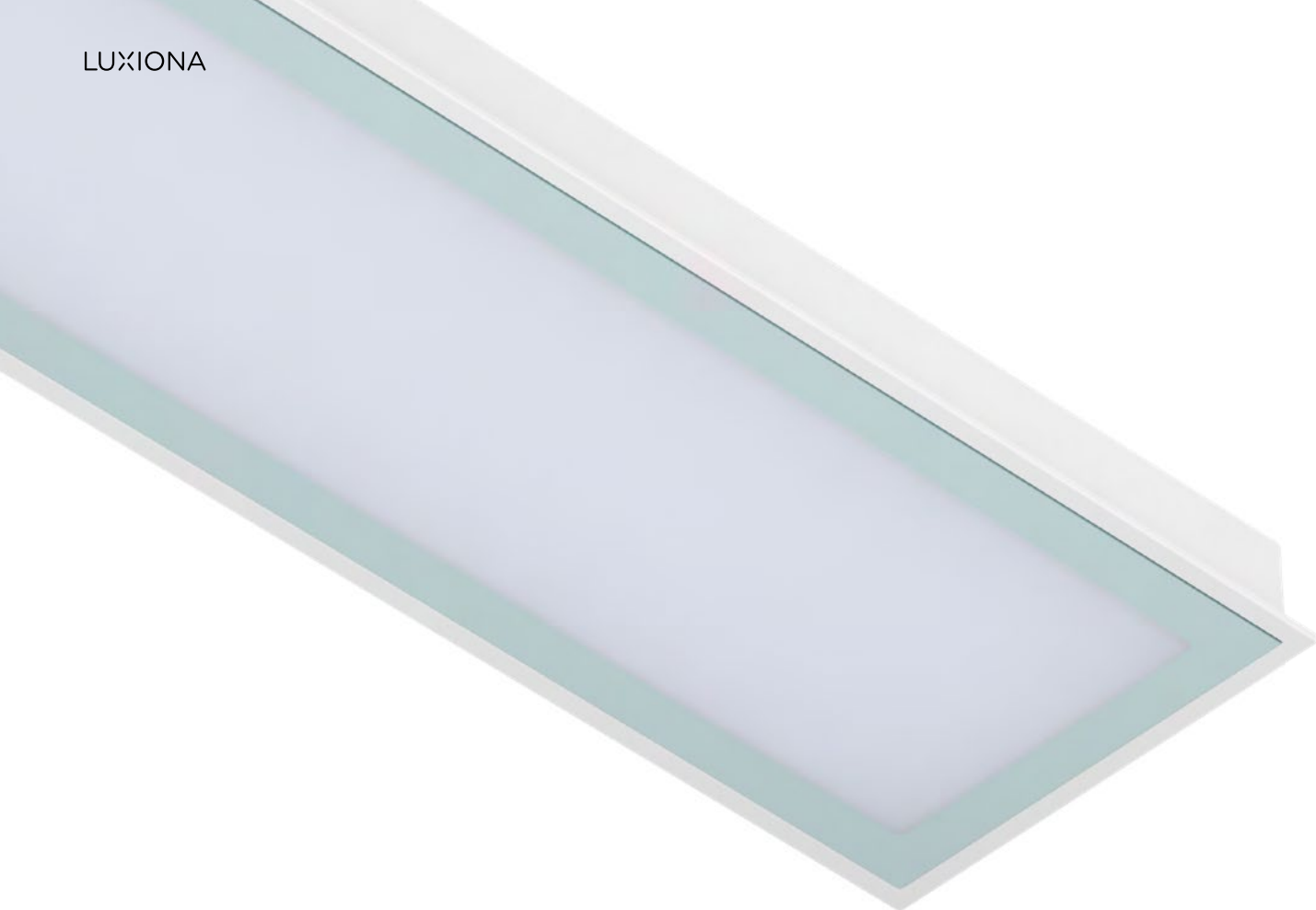

- Operating theatres - surgery rooms
- Surroundings of operating theatres (clean corridors)
- Intensive care rooms (ICU)
- Post-surgery recovery rooms
- Blood extraction rooms
- Laparoscopic & Endoscopic procedure rooms
- Patient rooms
- Consultancy & Doctors rooms
- Laboratories
- Dermatology & Dental offices
- Common areas: corridors, waiting areas
- Receptions
- Doctors common offices

Research laboratory & Pharmaceutical laboratory

- Clean rooms
- Research laboratories with laminar chambers
- Research laboratories without laminar chambers
- Precision production
- Food industry
- Underground car parks
- Outdoors: gardens, car parks



CLEAN CLASS 5-6	CRI >80	IP 65	IK 08
--------------------	------------	----------	----------

Agat Clean Class 5-6

Comfortable light thanks to efficient optical systems and diffusers mounted in aluminium frame. Designed for module suspended ceilings.



CLEAN CLASS 5-6	CRI >80	IP 65	IK 08
--------------------	------------	----------	----------

Agat Clean Class 5-6 No Frame

Top performance luminaire made of steel sheet, without an aluminium frame, which helps exclude unwanted contamination in clean rooms.



CLEAN CLASS 5-6	CRI >80	IP 65	IK 08
--------------------	------------	----------	----------

Rubin Clean Class 5-6

Top performance surface mounted luminaire. Body made of steel sheet with optical systems and diffusers placed in aluminium frame.



CLEAN CLASS 5-6	CRI >80	IP 65	IK 08
--------------------	------------	----------	----------

Rubin Clean Class 5-6 No Frame

Product dedicated to clean rooms with increased cleanliness class ISO 5-6. Designed for ceiling mounting and equipped with highly efficient LED panels. Available with a wide range of diffusers.

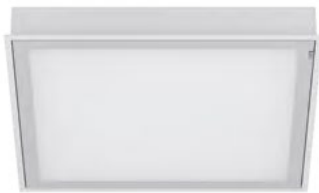

CLEAN CLASS 7-8-9	CRI >80	IP 65	IK 08
----------------------	------------	----------	----------

Agat Clean Class 7-8-9

Highly efficient luminaire designed for module suspended ceilings. Optical systems and diffusers mounted in an aluminium frame.



CLEAN CLASS 7-8-9	CRI >80	IP 65	IK 08
----------------------	------------	----------	----------

Rubin Clean Class 7-8-9

Top performance luminaire designed for surface mounting, with diffusers and optical systems placed in aluminium frame.

- 
- Operating theatres - surgery rooms
 - Surroundings of operating theatres (clean corridors)
 - Intensive care rooms (ICU)
 - Post-surgery recovery rooms
 - Blood extraction rooms
 - Laparoscopic & Endoscopic procedure rooms
 - Patient rooms
 - Consultancy & Doctors rooms
 - Laboratories
 - Dermatology & Dental offices
 - Common areas: corridors, waiting areas
 - Receptions
 - Doctors common offices
 - Research laboratory & Pharmaceutical laboratory

Clean rooms

Research laboratories with laminar chambers

Research laboratories without laminar chambers

Precision production

Food industry

- Underground car parks
- Outdoors: gardens, car parks



CLEAN CLASS 3-4	CRI >80	IP 65	IK 08
--------------------	------------	----------	----------

Agat Clean Class 3-4

Top performance thanks to highly efficient LED panels. Luminaire designed for module and cardboard suspended ceilings.



CLEAN CLASS 3-4	CRI >80	IP 65	IK 08
--------------------	------------	----------	----------

Agat Clean Class 3-4 No Frame

The luminaire is intended for clean rooms with an increased ISO 3-4 cleanliness class. Designed for suspended modular ceilings, equipped with highly efficient LED panels. Available with a wide range of diffusers.



CLEAN CLASS 3-4	CRI >80	IP 65	IK 08
--------------------	------------	----------	----------

Rubin Clean Class 3-4

Comfortable light thanks to efficient optical systems and diffusers mounted in aluminium frame. Designed for module suspended ceilings.



CLEAN CLASS 3-4	CRI >80	IP 65	IK 08
--------------------	------------	----------	----------

Rubin Clean Class 3-4 No Frame

High protection from contamination thanks to lack of aluminium frame or visible elements joining the diffuser and the luminaire body.



CLEAN CLASS 7-8-9	CRI >80	IP 65	IK 08
----------------------	------------	----------	----------

Agat Clean Class 7-8-9

Highly efficient luminaire designed for module suspended ceilings. Optical systems and diffusers mounted in an aluminium frame.



CLEAN CLASS 7-8-9	CRI >80	IP 65	IK 08
----------------------	------------	----------	----------

Rubin Clean Class 7-8-9

Top performance luminaire designed for surface mounting, with diffusers and optical systems placed in aluminium frame.



CRI >80	IP 44	SDCM 3	
------------	----------	-----------	--

Laminar LED

Streamlined, oval shape that makes it suitable for rooms with laminar flow ventilation. The air flowing around the luminaire is less susceptible to mechanical resistance. LED modules with color temperature 4000 K or with monochromatic yellow light.





Dr Irena Eris Cosmetics, Piaseczno. Poland



Production area for mechanical modules, Cleanroom, Eindhoven. Netherlands 81



- Operating theatres - surgery rooms
- Surroundings of operating theatres (clean corridors)
- Intensive care rooms (ICU)
- Post-surgery recovery rooms
- Blood extraction rooms
- Laparoscopic & Endoscopic procedure rooms
- Patient rooms
- Consultancy & Doctors rooms
- Laboratories
- Dermatology & Dental offices
- Common areas: corridors, waiting areas
- Receptions
- Doctors common offices
- Research laboratory & Pharmaceutical laboratory
- Clean rooms
- Research laboratories with laminar chambers
- Research laboratories without laminar chambers
- Precision production
- Food industry

Underground car parks
Outdoors: gardens, car parks



Neptun

Tightly-closed ceiling luminaires, ensuring additional protection against solid body penetration and jet of water from all directions. Perfect to be installed in moist and dusty rooms.



Numancia N

Luminaire adds in an PMMA lens system. Tempered glass diffuser. Multiple optical distributions: 30°, 60°, 90° and narrow asymmetrical. Designed for wall or ceiling surface mounting.



Beryl Proof Wall

An eye-catching, cylindrical luminaire that is suitable for mounting on walls, equipped with efficient LED sources. Perfect for decorative or accent lighting of building facades.



Tosca

Timeless design. Intended for installation on a hardened surface, equipped with high-performance, energy-saving LED sources of the latest generation.



Tosca Slim

Unobtrusive, elegant, and energysaving. Designed for installation on a hardened surface. Smaller diameter relative to the Tosca luminaire.



Filar

A minimalist design and simple form. Base made of aluminium and the diffuser tube made of acrylic satin, perfectly complements surroundings of architectural buildings.



Fasad

Highly effective luminaire resistant to all atmospheric conditions. Recommended for wall mounting or on top of solid surfaces. It will perfectly distinguish every architectural object.



Streetpark

Highly weather proof luminaire, equipped with adjustable handle designed for mounting on posts and arms. Lens optical system.



Kubik Pole 4D

Simple geometric form and resistance in all conditions. Luminaire for mounting on a hard surface, equipped with an optical system for various applications.



- Operating theatres - surgery rooms
- Surroundings of operating theatres (clean corridors)
- Intensive care rooms (ICU)
- Post-surgery recovery rooms
- Blood extraction rooms
- Laparoscopic & Endoscopic procedure rooms
- Patient rooms
- Consultancy & Doctors rooms
- Laboratories
- Dermatology & Dental offices
- Common areas: corridors, waiting areas
- Receptions
- Doctors common offices
- Research laboratory & Pharmaceutical laboratory
- Clean rooms
- Research laboratories with laminar chambers
- Research laboratories without laminar chambers
- Precision production
- Food industry
- Underground car parks

Outdoors: gardens, car parks - continuation



Kubik Pole T

T-shaped luminaire. Equipped with highly efficient, energy-saving LED sources with asymmetrical or symmetrical lenses, that provide uniform lighting.



Kubik LED

Ideal for selected outdoor spaces thanks to its elegant design and wide range of optical variants. Made in aluminium and powder paint to guarantee maximum resistance to weather conditions.



Kubik 1D

Outdoor luminaire to be mounted on dedicated foundation. LED module is additionally sealed with a special lens which at the same time ensures optimal wide light distribution.



Kubik 2D

Luminaire intended for mounting on the dedicated foundation (version 900 mm) or directly on a paved basis (version 300 mm and 600 mm). LED the module is sealed with a special lens that equips luminaire with optimal wide light distribution.



Kubik Pole

Outdoor luminaire for assembling on a hardened surface (concrete, sett or basement). IK09 strike resistant. Luminaire height: 300, 600, 900, 3000 and 4000 mm.



Kubik Pole ODB

Outdoor luminaire for assembling on a hardened surface. LED sources are placed in the upper part of the luminaire, and hidden within the construction, invisible for a potential viewer.



Kubik Pole Soft

Luminaire equipped with the latest generation of efficient, energy-saving LED sources. Designed to illuminate pedestrian routes, equipped with PC opal diffuser. Provides complete protection against dust and water. Impact resistant - IK08.



Pareo One

Body made from aluminum cast. Transparent diffuser is made from polycarbonate which is highly resistant to mechanical factors - IK09.



Non-Invasive Medicine Centre, The University Clinical Centre, Gdansk. Poland





UNIWERSYTET GDAŃSKI
CENTRUM MEDYCZNE
UNIWERSYTET MEDYCYNY

Selection of luminaires for hospitals

Technical information summary

More standard versions available at www.luxiona.com

Ask us for other variants different from those shown on our web in terms of light-gear-body.

Agat Clean

Name	Luminaire luminous flux [lm]	Efficiency [lm/W]	Power of luminaire [W]	Colour temperature [K]	Dimensions [mm]
Agat Clean ISO LED CRI95	From 4707 to 12964	Up to 132,3	From 39,2 to 102,5	4000	596 x 596 x 76 1196 x 296 x 76 1196 x 596 x 76
Agat Clean ISO No Frame LED CRI95	From 4707 to 12552	Up to 128,1	From 39,2 to 102,5		596 x 596 x 67 1196 x 296 x 67 1196 x 596 x 67
Agat Clean LED Smooth	From 2132 to 12074	Up to 159,3	From 16,3 to 117	3000 4000	596 x 296 x 76 596 x 596 x 76 1196 x 296 x 76 1196 x 596 x 76

Rubin Clean

Name	Luminaire luminous flux [lm]	Efficiency [lm/W]	Power of luminaire [W]	Colour temperature [K]	Dimensions [mm]
Rubin Clean ISO LED CRI95	From 4707 to 12964	Up to 132,3	From 39,2 to 102,5	4000	620 x 620 x 78 1210 x 310 x 78 1220 x 620 x 78
Rubin Clean ISO No Frame LED CRI95	From 4707 to 12552	Up to 128,1	From 39,2 to 102,5		574 x 574 x 69 1174 x 274 x 69 1174 x 574 x 69

Agat Clinic

Name	Luminaire luminous flux [lm]	Efficiency [lm/W]	Power of luminaire [W]	Colour temperature [K]	Dimensions [mm]
Agat Clinic	all scenes	4435	84,2	3000	595 x 595 x 130
	focused light	697	80,1		
	indirect light	879	65,1		
	direct light	2866	94		

Domino Clean

Name	Luminaire luminous flux [lm]	Efficiency [lm/W]	Power of luminaire [W]	Colour temperature [K]	Dimensions [mm]
Domino Clean LOW UGR LED	From 4712 to 6806	Up to 134,5	From 38 to 50,6	3000 4000	592 x 592 x 50

Topaz Clean

Name	Luminaire luminous flux [lm]	Efficiency [lm/W]	Power of luminaire [W]	Colour temperature [K]	Dimensions [mm]
Topaz ODG Clean AL LED	From 4757 to 7349	Up to 156,1	From 35,3 to 49,1	3000 4000	657 x 626 x 50-105
Topaz ODG Clean ST LED Smooth	From 4036 to 9759	Up to 161,9	From 33,2 to 65,3	4000	650 x 650 x 55-75

Artshape

Name	Luminaire luminous flux [lm]	Efficiency [lm/W]	Power of luminaire [W]	Colour temperature [K]	Dimensions [mm]
Artshape Round Small Edge	From 1492 to 11220	Consult us	From 25 to 76	3000	Ø650 x 85
Artshape Round Medium Edge			From 35 to 106		4000
Artshape Round Large Edge			From 50 to 140	TW	Ø1200 x 85
Artshape X			31 & 62		726 x 1000 x 80

Beryl New

Name	Luminaire luminous flux [lm]	Efficiency [lm/W]	Power of luminaire [W]	Colour temperature [K]	Dimensions [mm]
Beryl New LED O-1	From 852 to 4982	Up to 129,6	9,8 & 12,8	3000	Ø100 x 75
Beryl New LED O-2			From 16 to 25,5	4000	Ø165 x 100
Beryl New LED O-3			From 18,4 to 39,3	TW	Ø195 x 110

Domino

Name	Luminaire luminous flux [lm]	Efficiency [lm/W]	Power of luminaire [W]	Colour temperature [K]	Dimensions [mm]
Domino LOW UGR LED	From 542 to 7423	Up to 146,8	From 12,7 to 50,6	3000 4000	596 x 296 x 23
					596 x 75 x 50
					1196 x 296 x 23
					596 x 596 x 23
					1196 x 75 x 50
Domino LOW UGR LED Recessed			From 5,6 to 13		150 x 150 x 43
					250 x 250 x 43

Luxcan

Name	Luminaire luminous flux [lm]	Efficiency [lm/W]	Power of luminaire [W]	Colour temperature [K]	Dimensions [mm]
Luxcan C 15° CRI>80	From 1430 to 3602	Up to 140,9	12,8 18,8 26,4	3000	Ø85 x 205
Luxcan C 15° CRI>90					
Luxcan C 40° CRI>80					
Luxcan C 40° CRI>90			4000		
Luxcan C 60° CRI>80					
Luxcan C 60° CRI>90					
Luxcan R 13°	From 1611 to 4241	Up to 129,2	From 12,8 to 33,1	4000	Ø108 x 210
Luxcan R 36°					
Luxcan R 60°					

Patos

Name	Luminaire luminous flux [lm]	Efficiency [lm/W]	Power of luminaire [W]	Colour temperature [K]	Dimensions [mm]	
Patos-Line	From 899 to 14196	Up to 129,3	From 9 to 35,3	3000	566 x 77 x 81	
					1126 x 77 x 81	
					1406 x 77 x 81	
					4000 TW	1686 x 77 x 81
Patos O30				From 13 to 169		Ø324 x 150
Patos O45						Ø472 x 150
Patos O65						Ø672 x 150
Patos O80 LED		Ø822 x 164				
Patos O100 LED			Ø1022 x 164			
Patos O120 LED			Ø1222 x 164			

Filar

Name	Luminaire luminous flux [lm]	Efficiency [lm/W]	Power of luminaire [W]	Colour temperature [K]	Dimensions [mm]
Filar LED	From 2933 to 5867	Consult us	63 & 125	4000	300 x 300 x 2545 300 x 300 x 3045

Beryl Proof Wall

Name	Luminaire luminous flux [lm]	Efficiency [lm/W]	Power of luminaire [W]	Colour temperature [K]	Dimensions [mm]
Beryl Proof Wall LED Up&Down Narrow	From 1110 to 3959	Up to 168,9	From 8,9 to 25,2	3000 4000	210 x 120 x 370
Beryl Proof Wall LED Up&Down Medium					
Beryl Proof Wall LED Up&Down Wide					
Beryl Proof Wall LED Up Or Down Narrow					
Beryl Proof Wall LED Up Or Down Medium					
Beryl Proof Wall LED Up Or Down Wide					

Kubik

Name	Luminaire luminous flux [lm]	Efficiency [lm/W]	Power of luminaire [W]	Colour temperature [K]	Dimensions [mm]
Kubik Pole 4D	From 2411 to 5037	Up to 140,3	18,4 25,4 39,3	4000	220 x 220 x 1100 220 x 220 x 3000
Kubik Pole T	From 9400 to 28200	Up to 140,3	From 75 to 225	5700	1700 x 260 x 3000 1700 x 260 x 4000 1700 x 260 x 5000
Kubik LED 1x1,7W 24°	From 103 to 1062	Up to 140,3	3	3000 4000 6500	100 x 100 x 94
Kubik LED 1x1,7W 5°-21°			3		100 x 100 x 94
Kubik LED 1x2,4W 24°			4		100 x 100 x 94
Kubik LED 1x2,4W 5°-21°			4		100 x 100 x 94
Kubik LED 1x7,2W 24°			9		150 x 150 x 135
Kubik LED 1x7,2W 5°-21°			9		150 x 150 x 135
Kubik LED 2x1,7W 24°			5		100 x 100 x 94
Kubik LED 2x1,7W 5°-21°			5		100 x 100 x 94
Kubik LED 2x2,4W 24°			7		100 x 100 x 94
Kubik LED 2x2,4W 5°-21°			7		100 x 100 x 94
Kubik LED 2x7,2W 5°-21°			18		150 x 150 x 135
Kubik LED 3x1,7W 24°			7		100 x 100 x 94
Kubik LED 3x1,7W 5°-21°			7		100 x 100 x 94
Kubik LED 3x2,4W 24°			9		100 x 100 x 94
Kubik LED 3x2,4W 5°-21°			9		100 x 100 x 94
Kubik LED 4x1,7W 24°			10		100 x 100 x 94
Kubik LED 4x1,7W 5°-21°			10		100 x 100 x 94

Selection of luminaires for clean manufactory

Technical information summary

More standard versions available at www.luxiona.com

Ask us for other variants different from those shown on our web in terms of light-gear-body.

Agat Clean

Name	Luminaire luminous flux [lm]	Efficiency [lm/W]	Power of luminaire [W]	Colour temperature [K]	Dimensions [mm]
Agat Clean Class LED	From 3589 to 15111	Up to 160,5	From 28,2 to 100,5	3000 4000	596 x 596 x 76 1196 x 296 x 76 1196 x 596 x 76
Agat Clean Class No Frame LED	From 3589 to 15111	Up to 160,5	From 28,2 to 100,5	3000 4000	596 x 596 x 67 1196 x 296 x 67 1196 x 596 x 67

Rubin Clean

Name	Luminaire luminous flux [lm]	Efficiency [lm/W]	Power of luminaire [W]	Colour temperature [K]	Dimensions [mm]
Rubin Clean Class LED	From 3589 to 15111	Up to 160,5	From 28,2 to 100,5	3000 4000	620 x 620 x 78 1210 x 310 x 78 1220 x 620 x 78
Rubin Clean Class No Frame LED	From 3589 to 15111	Up to 160,5	From 28,2 to 100,5	3000 4000	574 x 574 x 69 1174 x 274 x 69 1174 x 574 x 69

Artshape

Name	Luminaire luminous flux [lm]	Efficiency [lm/W]	Power of luminaire [W]	Colour temperature [K]	Dimensions [mm]
Artshape Round Small Edge	From 1492 to 11220	Consult us	From 25 to 76	3000	Ø650 x 85
Artshape Round Medium Edge			From 35 to 106		4000
Artshape Round Large Edge			From 50 to 140	TW	Ø1200 x 85
Artshape X			31 & 62		726 x 1000 x 80

Beryl New

Name	Luminaire luminous flux [lm]	Efficiency [lm/W]	Power of luminaire [W]	Colour temperature [K]	Dimensions [mm]
Beryl New LED O-1	From 852 to 4982	Up to 129,6	9,8 & 12,8	3000	Ø100 x 75
Beryl New LED O-2			From 16 to 25,5	4000	Ø165 x 100
Beryl New LED O-3			From 18,4 to 39,3	TW	Ø195 x 110

Domino

Name	Luminaire luminous flux [lm]	Efficiency [lm/W]	Power of luminaire [W]	Colour temperature [K]	Dimensions [mm]
Domino LOW UGR LED	From 542 to 7423	Up to 146,8	From 12,7 to 50,6	3000 4000	596 x 296 x 23 596 x 75 x 50 1196 x 296 x 23 596 x 596 x 23 1196 x 75 x 50
Domino LOW UGR LED Recessed			From 5,6 to 13		150 x 150 x 43 250 x 250 x 43

Luxcan

Name	Luminaire luminous flux [lm]	Efficiency [lm/W]	Power of luminaire [W]	Colour temperature [K]	Dimensions [mm]
Luxcan C 15° CRI>80	From 1430 to 3602	Up to 140,9	12,8 18,8 26,4	3000 4000	Ø85 x 205
Luxcan C 15° CRI>90					
Luxcan C 40° CRI>80					
Luxcan C 40° CRI>90					
Luxcan C 60° CRI>80					
Luxcan C 60° CRI>90					
Luxcan R 13°	From 1611 to 4241	Up to 129,2	From 12,8 to 33,1	4000	Ø108 x 210
Luxcan R 36°					
Luxcan R 60°					

Patos

Name	Luminaire luminous flux [lm]	Efficiency [lm/W]	Power of luminaire [W]	Colour temperature [K]	Dimensions [mm]
Patos-Line	From 899 to 14196	Up to 129,3	From 9 to 35,3	3000 4000 TW	566 x 77 x 81
Patos O30					1126 x 77 x 81
					1406 x 77 x 81
					1686 x 77 x 81
			Ø324 x 150		
			Ø472 x 150		
			Ø672 x 150		
			Ø822 x 164		
Patos O100 LED	Ø1022 x 164				
Patos O120 LED	Ø1222 x 164				
Patos O65	From 13 to 169				Ø672 x 150
Patos O80 LED					Ø822 x 164
Patos O100 LED					Ø1022 x 164
Patos O120 LED					Ø1222 x 164

Filar

Name	Luminaire luminous flux [lm]	Efficiency [lm/W]	Power of luminaire [W]	Colour temperature [K]	Dimensions [mm]
Filar LED	From 2933 to 5867	Consult us	63 & 125	4000	300 x 300 x 2545 300 x 300 x 3045

Beryl Proof Wall

Name	Luminaire luminous flux [lm]	Efficiency [lm/W]	Power of luminaire [W]	Colour temperature [K]	Dimensions [mm]
Beryl Proof Wall LED Up&Down Narrow	From 1110 to 3959	Up to 168,9	From 8,9 to 25,2	3000 4000	210 x 120 x 370
Beryl Proof Wall LED Up&Down Medium					
Beryl Proof Wall LED Up&Down Wide					
Beryl Proof Wall LED Up Or Down Narrow					
Beryl Proof Wall LED Up Or Down Medium					
Beryl Proof Wall LED Up Or Down Wide					

Kubik

Name	Luminaire luminous flux [lm]	Efficiency [lm/W]	Power of luminaire [W]	Colour temperature [K]	Dimensions [mm]
Kubik Pole 4D	From 2411 to 5037	Up to 140,3	18,4 25,4 39,3	4000	220 x 220 x 1100 220 x 220 x 3000
Kubik Pole T	From 9400 to 28200	Up to 140,3	From 75 to 225	5700	1700 x 260 x 3000 1700 x 260 x 4000 1700 x 260 x 5000
Kubik LED 1x1,7W 24°	From 103 to 1062	Up to 140,3	3	3000 4000 6500	100 x 100 x 94
Kubik LED 1x1,7W 5°-21°			3		100 x 100 x 94
Kubik LED 1x2,4W 24°			4		100 x 100 x 94
Kubik LED 1x2,4W 5°-21°			4		100 x 100 x 94
Kubik LED 1x7,2W 24°			9		150 x 150 x 135
Kubik LED 1x7,2W 5°-21°			9		150 x 150 x 135
Kubik LED 2x1,7W 24°			5		100 x 100 x 94
Kubik LED 2x1,7W 5°-21°			5		100 x 100 x 94
Kubik LED 2x2,4W 24°			7		100 x 100 x 94
Kubik LED 2x2,4W 5°-21°			7		100 x 100 x 94
Kubik LED 2x7,2W 5°-21°			18		150 x 150 x 135
Kubik LED 3x1,7W 24°			7		100 x 100 x 94
Kubik LED 3x1,7W 5°-21°			7		100 x 100 x 94
Kubik LED 3x2,4W 24°			9		100 x 100 x 94
Kubik LED 3x2,4W 5°-21°			9		100 x 100 x 94
Kubik LED 4x1,7W 24°			10		100 x 100 x 94
Kubik LED 4x1,7W 5°-21°			10		100 x 100 x 94



HOPITAL DU P



F. Muller Dental-Technik, Berlin. Germany



F. Muller Dental-Technik, Berlin. Germany 95



Sant Joan de Reus Hospital. Spain





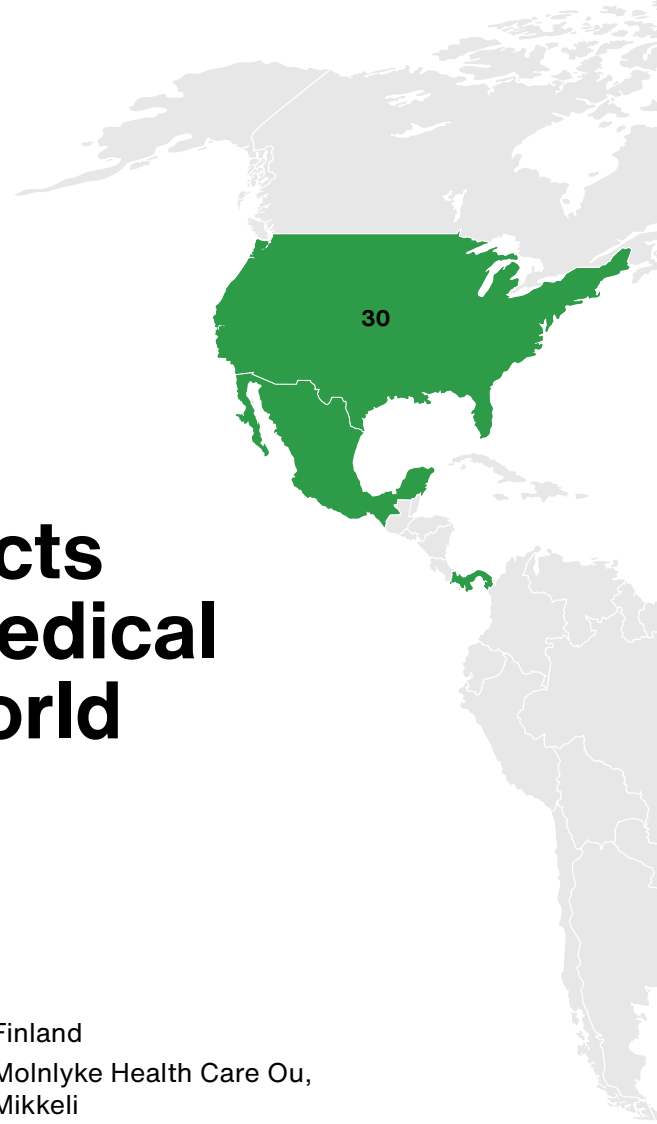

Chosen projects for Clean & Medical around the world

1. Austria
Landeskrankenhaus Hainburg
2. Azerbaijan
1340 Baku
3. Belarus
5th City Hospital
4. Belgium
Greif Cleanroom, Izegem
5. China
Crown Tech, Xinjiang Province
6. Croatia
KBC Osijek
Hospital Našice
Hospital Koprivnica
7. Denmark
Glostrup Apotek, Glostrup
Philips Medisize Cleanroom, Struer
8. Estonia
Private Clinic in Nomme, Tallin
Tartu Hospital
9. Finland
Molnlycke Health Care Oyj, Mikkeli
Laboratory, Mikkeli
Biocity Laboratory, Turku
10. France
Strasbourg University Hospitals
Centre Hospitalier Intercommunal, Castres
Hospital Centre Laennec, Creil
11. Germany
Martini Klinik, Hamburg
Bayer Covestro Folienfabrik, Dormagen
Krankenhaus Stuttgart
Klinikum Charité Benjamin Franklin, Berlin
Böhringer Ingelheim
microParts GmbH, Dortmund
Intuitive Surgical GmbH, Freiburg

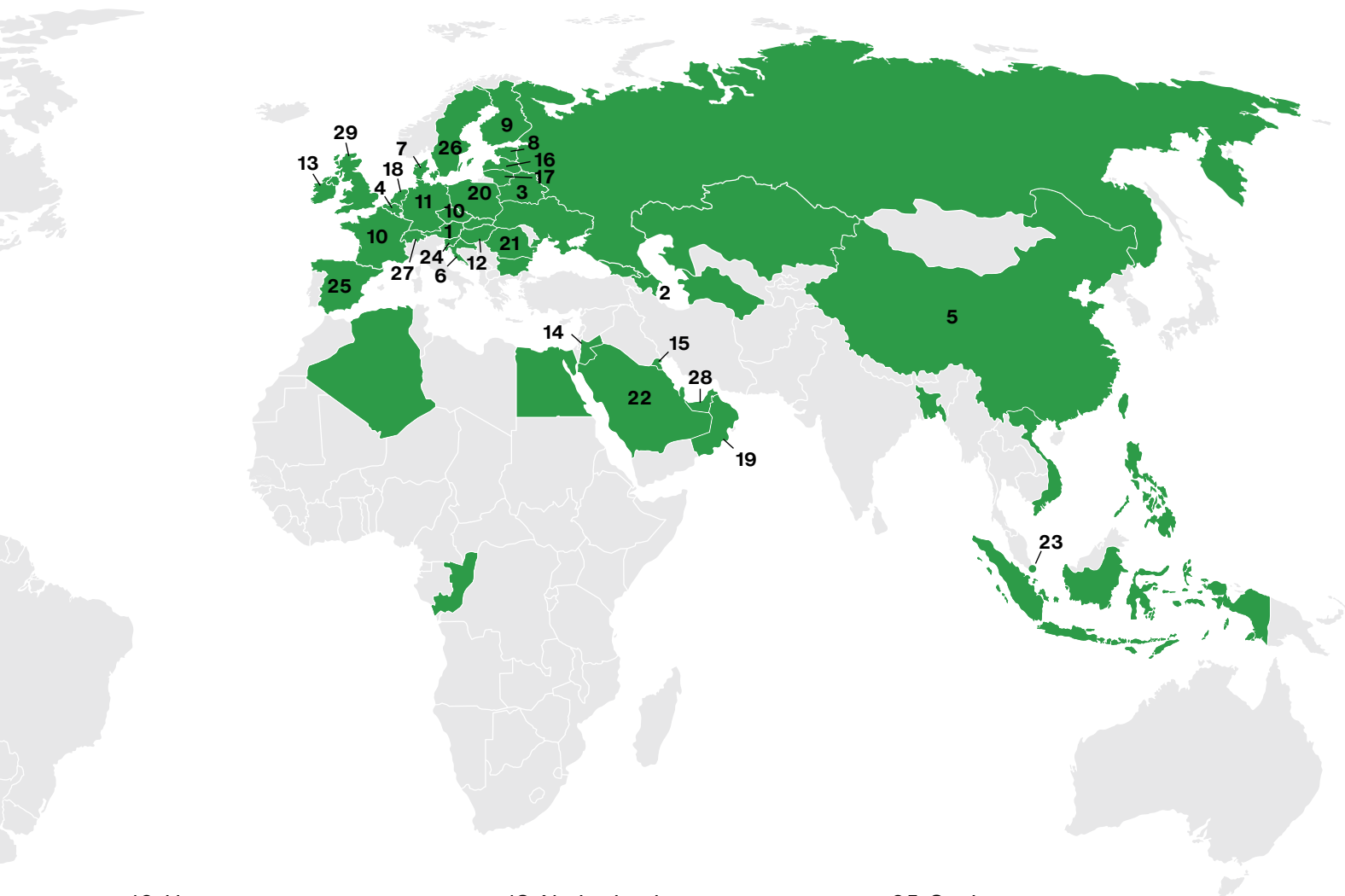

- | | | |
|--|--|--|
| <p>12. Hungary
 DSA Laboratory, Pecs
 Medicover Clinic, Budapest
 Flisom Hungary KFT,
 Kecskemét</p> | <p>18. Netherlands
 Mechatronics Cleanroom
 Laboratory, Eindhoven
 Sint Maartenskliniek,
 Nijmegen</p> | <p>25. Spain
 Mutua de Granollers,
 Barcelona
 Sant Joan de Reus Hospital
 Nu Clinic Sant Cugat,
 Barcelona
 Grifols
 Almirall
 Institut Oncològic
 de Barcelona</p> |
| <p>13. Ireland
 Carten Controls, Waterford
 AQF Medical - Cleanroom,
 Meath</p> | <p>19. Oman
 Muscat - Royal Expansion
 Mouwasat Hospital</p> | <p>26. Sweden
 APL Cleanroom, Gothenburg
 Carballo Klinik</p> |
| <p>14. Jordan
 Al Kindl</p> | <p>20. Poland
 GlaxoSmithKline
 Pharmaceuticals, Poznan
 Hybrid OR, Olsztyn
 Non-invasive Medicine
 Centre, Gdansk</p> | <p>27. Switzerland
 St. Clarashospital Basel</p> |
| <p>15. Kuwait
 Chest Hospital Kuwait
 Jaah Hospital</p> | <p>21. Romania
 Hospital Bagdasar,
 Bucharest
 Polaris Clinic, Cluj-Napoca</p> | <p>28. United Arab Emirates
 Dubai Showroom</p> |
| <p>16. Latvia
 Stradina Hospital, Riga
 Liepajas Regional Hospital
 Riga 1st Hospital</p> | <p>22. Saudi Arabia
 Saudi Arabien Medinah
 Hospital</p> | <p>29. United Kingdom
 Noumed Life Sciences,
 Maidenhead
 Coca Colla Lisburn
 Roodlane Medical Clinique,
 London</p> |
| <p>17. Lithuania
 Affidea Clinic, Vilnius
 Odonthology Clinic, Alytus
 Pilenu Klinika, Marijampole</p> | <p>23. Singapur
 NCID Singapur</p> | <p>30. USA
 Kite Pharma, Washington</p> |
| <p>24. Slovenia
 TIK Kobarid
 University of Ljubljana
 (clean room)</p> | | |

LUXIONA worldwide



Commercial offices:

Spain, Poland, France, Italy, Germany

Logistic Centre:

Spain, China

Production:

Poland / Spain (emergency)



LUXIONA

LUXIONA Headquarters

C/ Tuset, 20
08006, Barcelona
Spain
+34 938 466 909
info@luxiona.com

Spain

C/ Tuset, 20
08006, Barcelona
Spain
+34 938 466 909
info@luxiona.com

Export

Export Department
+48 505 695 638
customer.care@luxiona.com

Poland

ul. Sochaczewska 110
Macierzysz
05-850 Ozarow Mazowiecki
Poland
+48 22 721 72 72
info.poland@luxiona.com

Germany

Westhafenstraße 1
13353 Berlin,
Germany
+49 3040 535 600
info@luxiona.de

France

7 Rue Colonel Chambonnet
69500 Bron
France
+33 472 146 666
info.france@luxiona.com

Italy

Via Luigi Cadamosto 4
26900 Lodi (LO)
Italy
+39 0 298 274 010
info.italy@luxiona.com

Marketing
marketing@luxiona.com

Purchasing
globalpurchasing@luxiona.com

luxiona.com

support@luxiona.com

[Linkedin.com/company/luxiona](https://www.linkedin.com/company/luxiona)
 [Facebook.com/luxionagroup](https://www.facebook.com/luxionagroup)
 [Instagram.com/luxionagroup](https://www.instagram.com/luxionagroup)
 [YouTube: Luxiona Group](https://www.youtube.com/Luxiona Group)

