



Gran **V**ia

LUXIONA

EN

Index

3	Created in Barcelona
6	System explanation
9	System applications
20	Technical information
30	GranVia & GranVia Pro trunking rail
32	GranVia Pro luminous fitting
38	GranVia Standard luminous fitting
44	Accessories
48	Luxiona worldwide
48	Contact

Aerial view of Barcelona

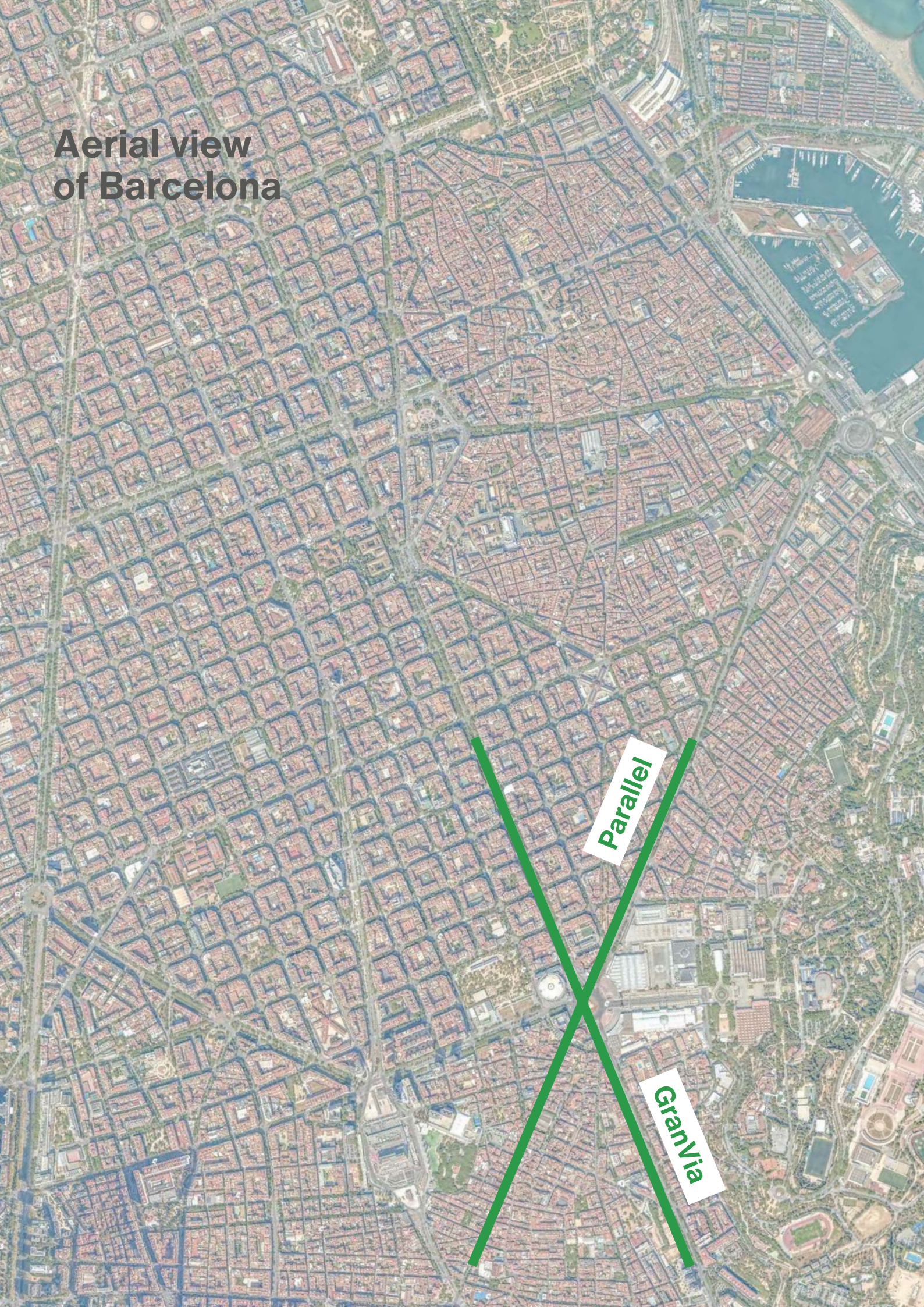

Parallel

Gran Via

Created in Barcelona

GranVia – a new rail system inspired by an iconic Barcelona street

At Luxiona, headquartered in the vibrant city of Barcelona, innovation and design converge to create lighting solutions that provide flexibility and the highest efficiency. Our commitment to excellence is reflected in every aspect of our product's design and functionality. From concept to creation, our team meticulously crafts each detail, ensuring that LUXIONA luminaires exceed the highest quality and performance standards.

Now, introducing GranVia, a highly energy-efficient linear rail system designed for creating continuous lines in industrial, warehouse and commercial spaces. Named after the street of Barcelona, which is a main artery of the city and the largest street in the country, this system is to become an outstanding product in Luxiona's portfolio.

GranVia embodies the spirit of connectivity, just as the Gran Via street connects neighbourhoods and many singular tourist points of Barcelona, our GranVia lighting system is designed to connect different lighting systems seamlessly within your space. By complimenting GranVia trunking lines with projectors, emergency systems, suspended high-bay systems and more, GranVia offers end-to-end solutions that combine functionality with aesthetics.

As the newest addition to our industrial and retail linear lighting systems, GranVia complements our existing Parallel line, offering versatility and flexibility to meet the unique needs of any project.

LUXIONA uses ArcelorMittal steels



Highest quality steel

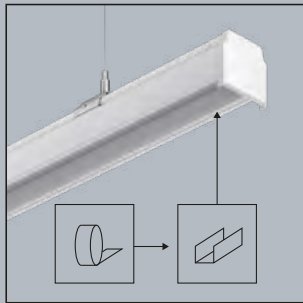

Surface or suspended installation

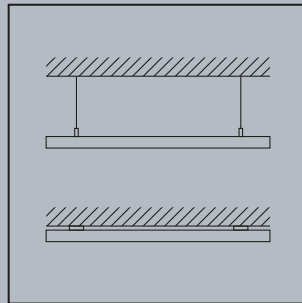

Easy height adjustment (suspended version)

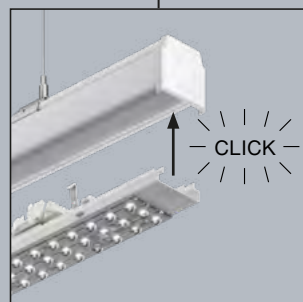
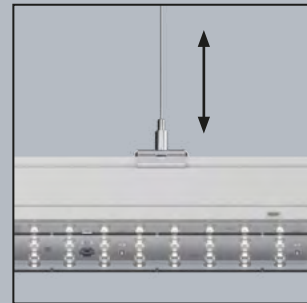

Two-pieces structure

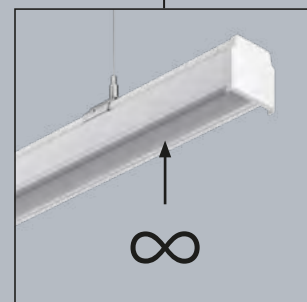

Unlimited possibilities

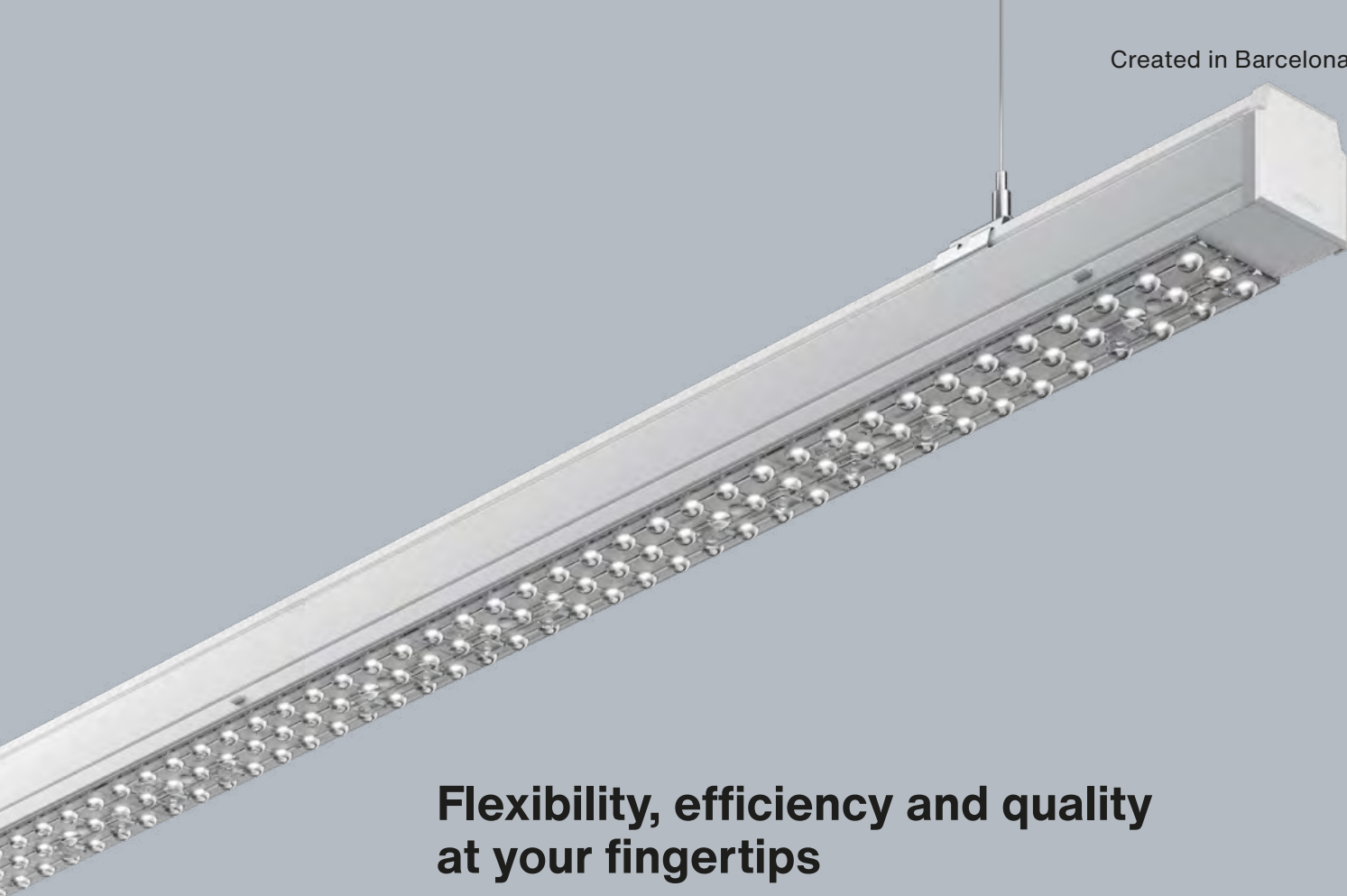

Flexibility, efficiency and quality at your fingertips

The GranVia trunking rail by LUXIONA is designed for quick and easy tool-less installation, making it an ideal solution for versatile lighting needs. At the core of GranVia's design lies its dual-component structure, comprising rail and luminaire units. This modular arrangement empowers users with flexibility and competitiveness, placed in the trunking rail allowing for easy adaptation to diverse spatial requirements and architectural contexts.

The intuitive design allows for a simple click-in connection, where you can effortlessly place the luminaire in the rail. This system is equipped with a joint connector, enabling the smooth and rapid installation of a continuous-row system. Multiple luminaires can be placed in together without the need for any additional tools or accessories, thanks to the straightforward design that ensures both electrical and mechanical connections are secure. Continuity of work is guaranteed due thanks to hot-replacement, without the need for electricity cuts or work disruptions thanks to its two-piece structure.

With a quick and toolless installation both on the surface or suspension by steel slings, the system is easily adapted to all kinds of spaces in retail and industrial environments. The suspension system of the GranVia trunking rail is designed for ease and convenience, allowing for quick attachment and adjustments. You can easily modify the height to suit the specific requirements of your space, providing flexibility and adaptability in various environments.

LUXIONA's strategic collaboration with ArcelorMittal, one of the world's biggest and premier steel manufacturer, ensures the incorporation of high quality steel with superior durability. By utilizing ArcelorMittal's advanced technologies and R&D expertise, we deliver product with enhanced structural integrity and reliability. This partnership guarantees that you receive first-class products, ensuring exceptional performance and longevity in all applications.

LUXIONA uses ArcelorMittal steels





System explanation

Key characteristics overview

Unlimited possibilities thanks to the 2 piece (rail+luminaire) structure:

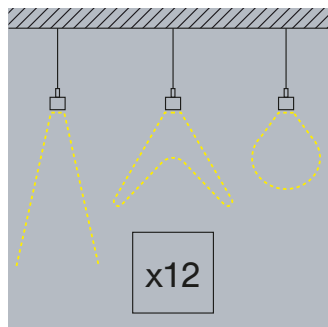

12 light distributions

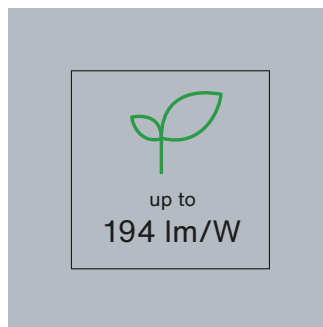

Achieve 194 lm/W

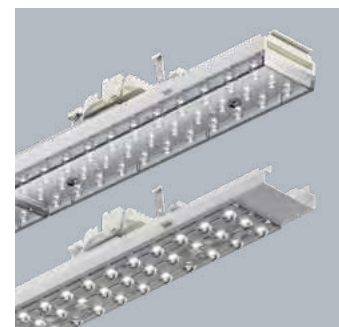

IP20 & IP54 version

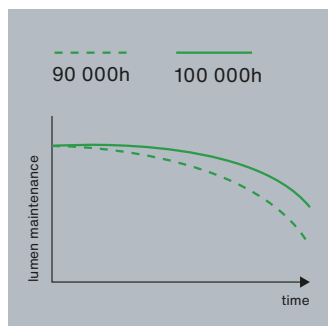

90 000h and 100 000h versions

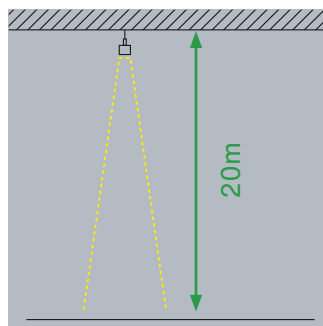

High luminous flux adapted to almost 20 m height

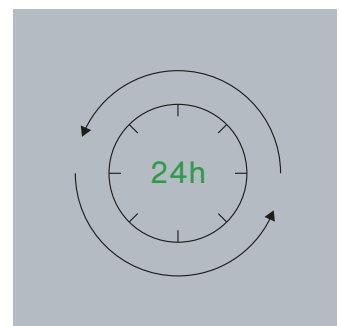

Continuity of works in the premises



Customise to your specific needs

GranVia offers unparalleled customisation capabilities tailored to the precise requirements of any chosen project or space. Leveraging the strategic advantage of manufacturing in Poland, this solution empowers us to efficiently cater to large-scale projects requiring swift responsiveness and customised products.

CCT
☀️



GranVia provides versatility in Correlated Colour Temperature (CCT), accommodating preferences ranging from 5000K to 6500K **on request**. This flexibility ensures optimal lighting ambiance and visual comfort tailored to the unique characteristics of each space.

CRI
👁️

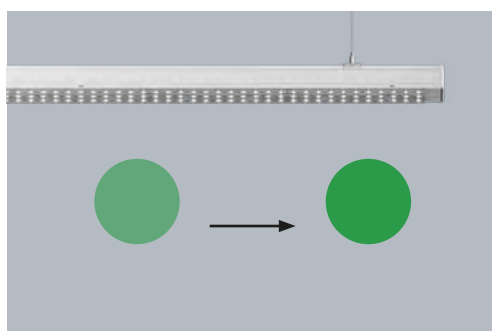

With the possibility to specify **on request** the Colour Rendering Index (CRI) to meet exacting standards, with options such as 90 and beyond, you can ensure that colours will appear as they should. Especially in retail spaces where high CRI values make products look their best.

RAL
📏

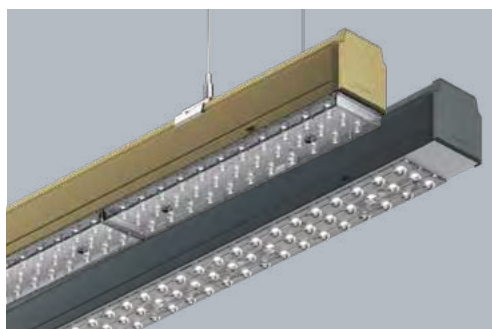

The colour of GranVia luminaires' bodies can be customised **on request** to any desired hue using the chosen colour from the RAL palette, enabling seamless integration with architectural aesthetics, especially in commercial spaces.



Respect for the environment. Maximum savings for your budget.

GranVia combines excellent luminous efficacy with longest durability and uniform light-emitting surface that ensures that the light looks homogeneous, creating the perfect conditions both in industrial and retail spaces.

GranVia's impressive efficiency of up to 194 lumens per watt means that the luminaires produce more light using less energy, leading to substantial energy savings and reduced operational costs for investors and building owners. The benefits include lower electricity bills and a reduced carbon footprint, contributing to a more sustainable and environmentally friendly operation.

Durability is another critical aspect of the GranVia luminaires, with extended lifespans of up to 90 000 to 100 000 hours. This longevity means fewer replacements and maintenance interventions, translating to lower maintenance costs and less disruption to building operations. For investors and building owners, this durability

means reduced long-term expenses and the reassurance of a reliable lighting solution. The long LED lifespan and consistently good light quality allows investors to budget for fewer luminaires in the project, thus saving on investment costs and energy. The combination of high efficiency and durability maximises the return on investment. The long lifespan ensures that the energy savings are sustained over many years, amplifying the benefits of the initial energy-efficient investment, which makes GranVia a perfect choice for the lighting replacement projects and facilities looking to apply for certifications such as BREEAM, LEED and other.

Environmental impact throughout GranVia's life cycle – such as its carbon footprint and the production of waste—is significantly lower. This makes GranVia luminaires a smart and sustainable choice for all kind of investments in the various retail, industrial, public and sports spaces.

Lifetime
90 000 h
100 000 h

**Unique
efficiency**
up to
194 lm/W



System applications

Maximum adaptability with a single rail system

GranVia is the ultimate adaptable lighting solution for a wide range of applications. It easily adjusts to various retail environments, from small supermarkets to large hypermarkets, and excels in industrial and logistics spaces, including compact warehouses and large distribution centres. GranVia's flexibility accommodates both low-ceilinged and high-ceilinged areas, delivering optimal illumination for enhanced customer experiences in retail and improved productivity in industrial settings. With diverse

luminous flux options, GranVia effectively lights spaces of varying needs, such as warehouses, retail spaces, offices and schools and gymnasiums.

Its exceptional efficiency and impressive service life ensure low operating costs without compromising quality. GranVia offers limitless possibilities, providing superior lighting solutions with unmatched flexibility and precision.



Production halls



Warehouses



Supermarkets



Schools



Gymnasiums



Public spaces

GranVia for industry premises

The GranVia is an outstanding choice for industrial applications, designed to meet the diverse lighting requirements of various areas within warehouses and production halls, ensuring optimal illumination and operational efficiency, reliable performance, and longevity even in harsh environments.

In industrial warehouses, GranVia's 12 different light distributions (8 available in the IP20 version and 4 in the IP54 version) can be used to provide focused and effective illumination for different shelving areas. This ensures that all stored goods are clearly visible, facilitating easier retrieval and inventory management. The precise lighting reduces the risk of errors and enhances safety in narrow and tall shelving aisles.

Designed to provide higher luminous flux adapted to nearly 20-metre-high interiors, GranVia ensures that the high-rack warehouse remains brightly

and evenly illuminated even at great heights, enhancing visibility and safety across the entire area.

For production halls, proper lighting is crucial for detailed tasks and quality control processes, providing workers with the clarity needed to perform their work efficiently and safely.

The high CRI ensures true colour representation, which is essential in production settings. GranVia provides even and consistent lighting throughout large industrial spaces, eliminating dark spots and ensuring a well-lit environment. This enhances overall safety by reducing the risk of accidents and improving the comfort for employees.

With both IP20 and IP54 versions available, GranVia luminaires are highly suitable for the demanding conditions often found in industrial settings, including dusty and humid areas.



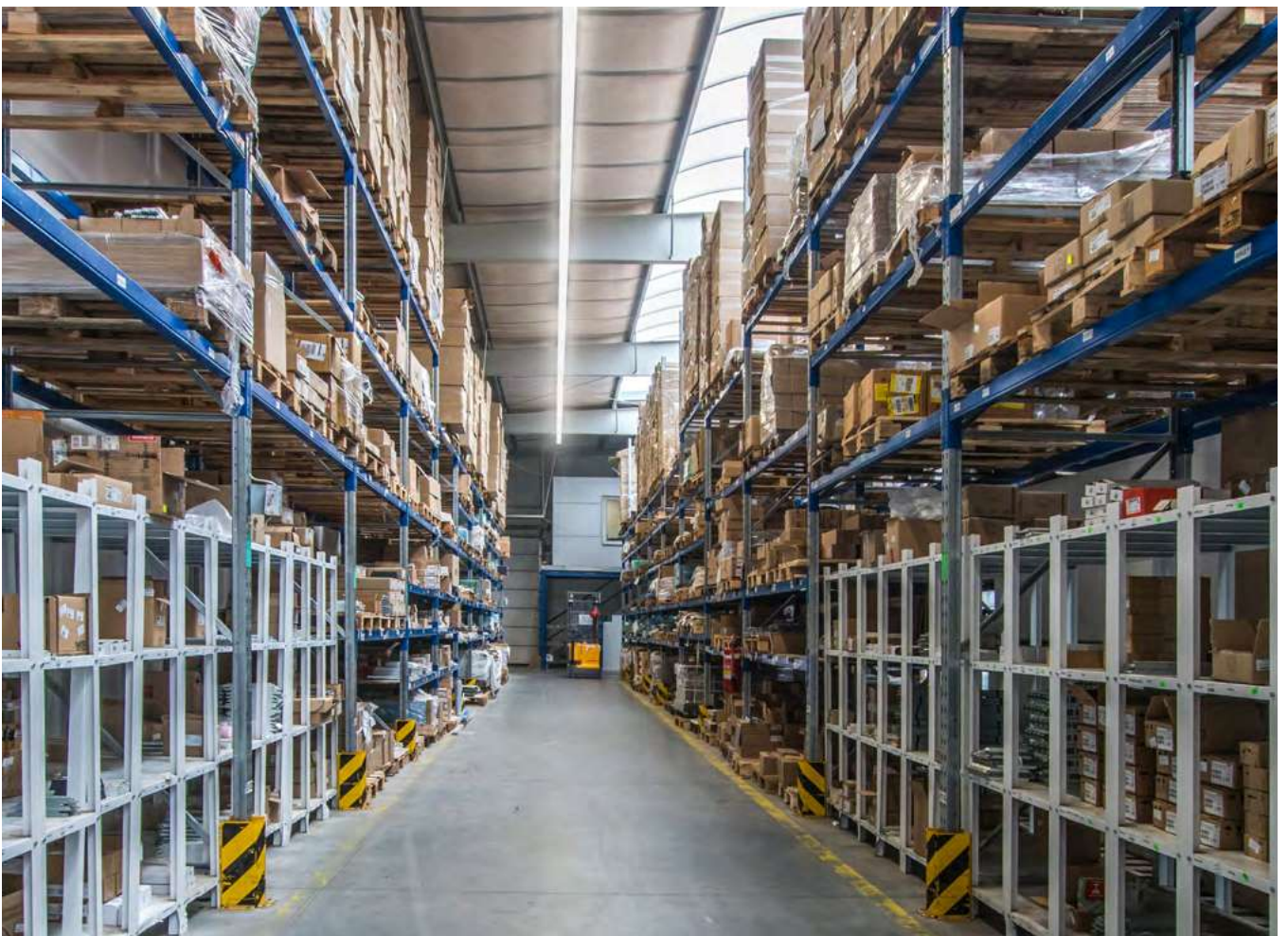





7

8

9

10

ADVANCE
TECH

XL
FLAT SCREEN
STORAGE

GranVia for retail spaces

GranVia offers versatility that makes it ideal for a variety of retail environments. With 12 different light distributions, it can be adapted to effectively highlight product displays. Focused and asymmetrical beams draw attention to key shelving areas and displays that attract customers, enhance the visibility of products, and make them more appealing and easier to find. For general lighting in aisles, GranVia's wide light distributions ensure uniform lighting, eliminating dark spots and enhancing the overall brightness of the store.

Customisable colour temperature and CRI >90 ensure that both customers and staff experience lighting optimal for their well-being. Accurate colour rendering is crucial for the shopping experience, providing clarity and reducing eye strain. The ability to adjust the colour temperature ensures that fresh food is always presented in the best light, drawing attention and enhancing sales. Availability in IP20 and IP54 versions

makes it a suitable solution for the supermarket's warehouses, allowing storage spaces to be optimally lit. Additionally, the system helps avoid glare by reflection, ensuring a comfortable and efficient checkout process.

Customisable body colour allows the luminaires to match the store's interior design or stand out as design elements themselves. This feature is particularly beneficial where the luminaire can contribute to the store's aesthetic appeal while providing functional lighting.

The toolless, quick click-in installation of GranVia ensures that setting up and adjusting the lighting is straightforward and hassle-free. This is particularly advantageous in retail spaces that require frequent reconfiguration for displays or layout changes, allowing for minimal disruption and maximum flexibility.

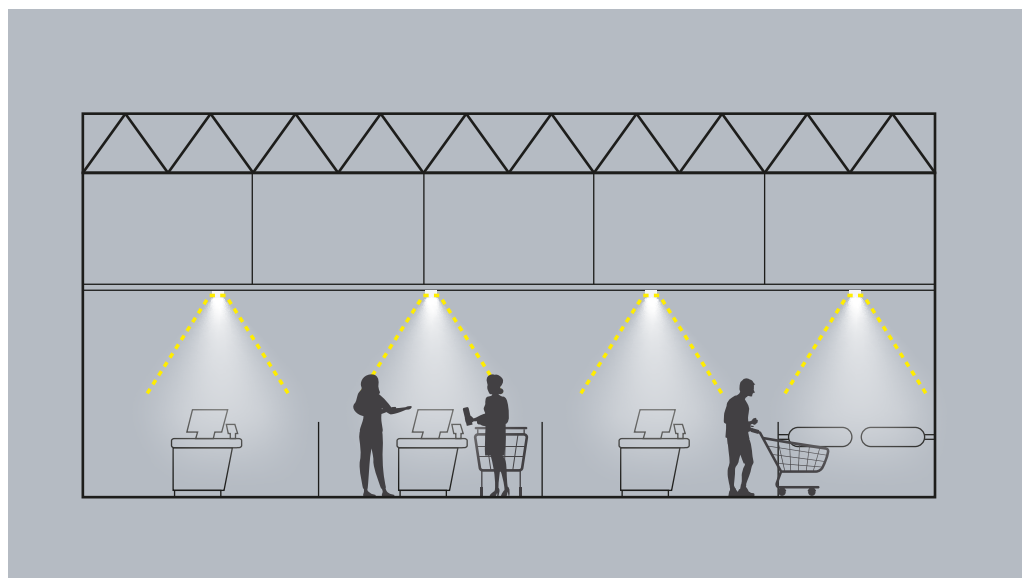



GranVia for schools and gymnasiums

GranVia is an exceptional choice for schools, gymnasiums and sports classrooms, offering tailored lighting solutions to support various activities in these dynamic environments. In classrooms, it delivers uniform, efficient and glare-free lighting, enhancing learning environments. Meanwhile, in gymnasiums, GranVia ensures proper visibility and safety

without glare, with different light distributions, and IP20 and IP54 versions to accommodate different needs. With quick installation, energy efficiency and customisable designs, GranVia is a versatile lighting solution for modern workplaces, educational institutions, and public facilities.

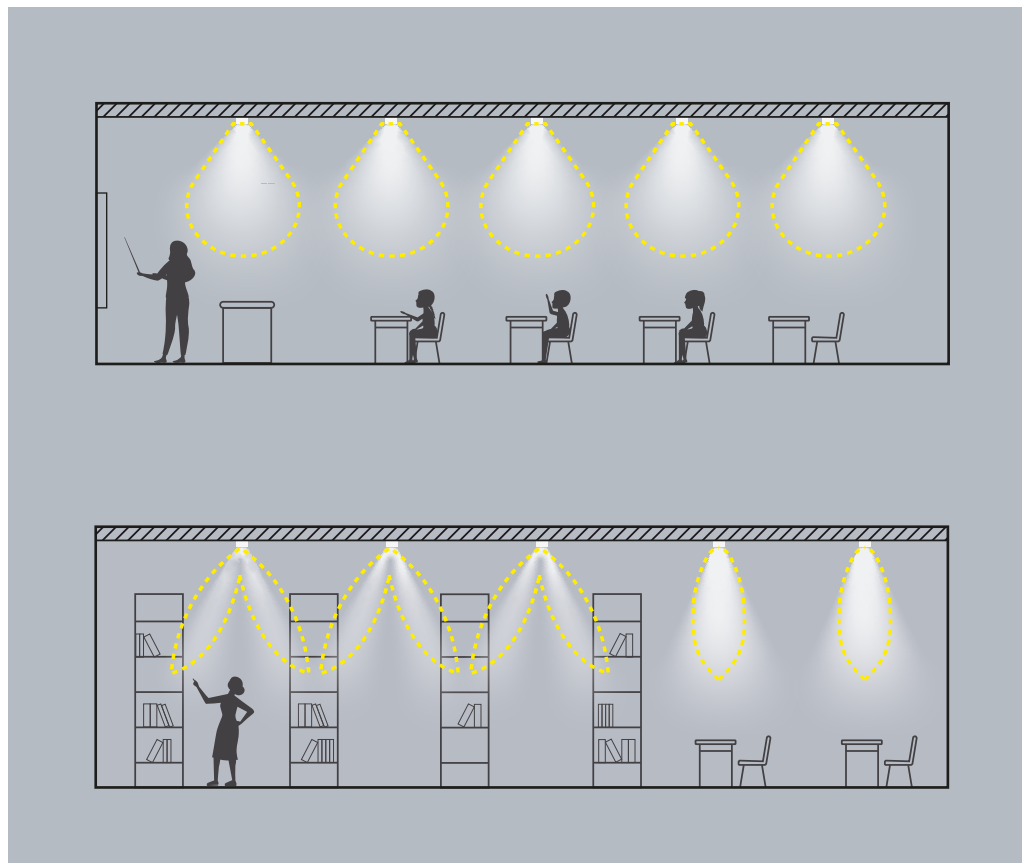

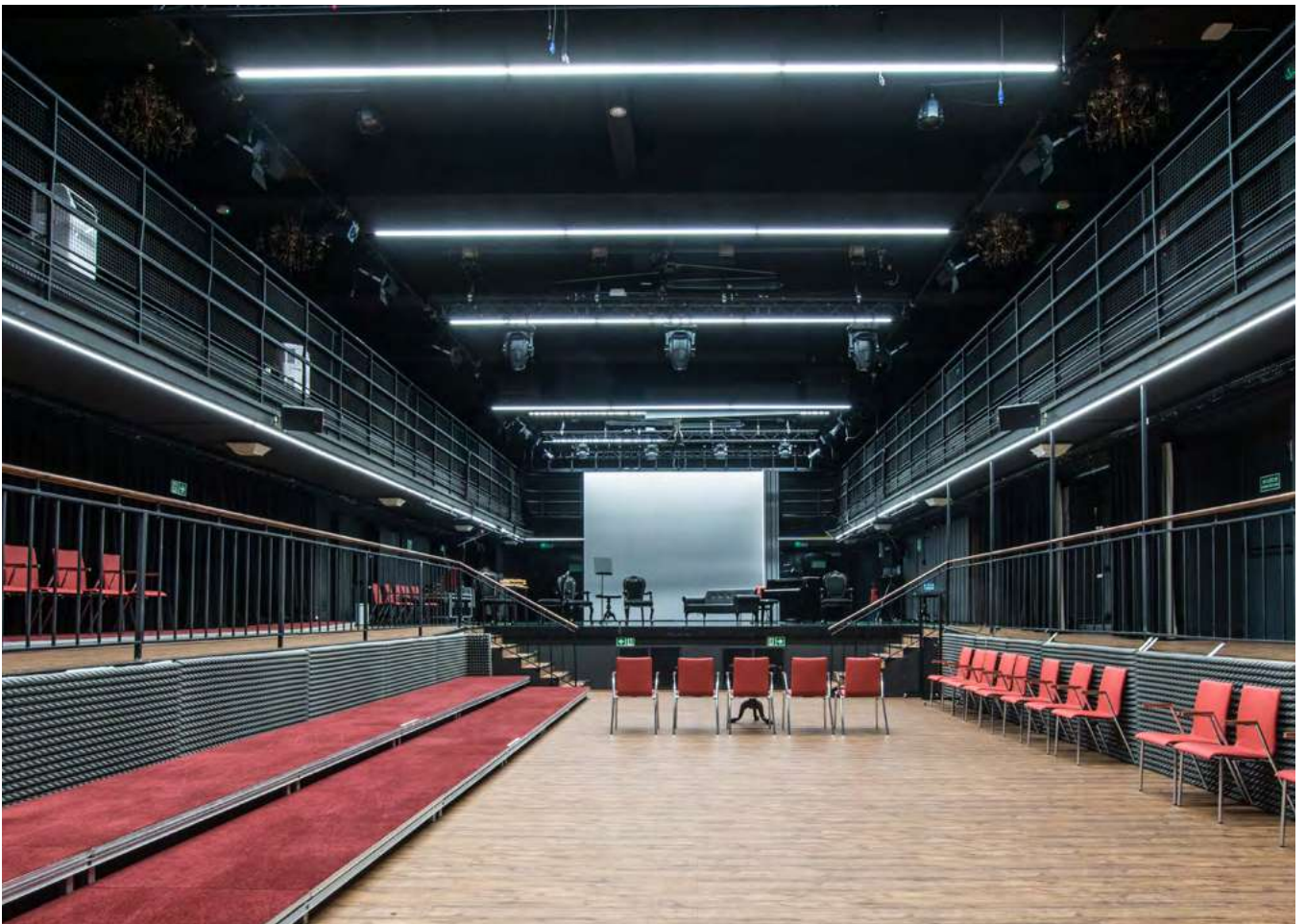

Fresh Food

Drinks





Technical information

System overview

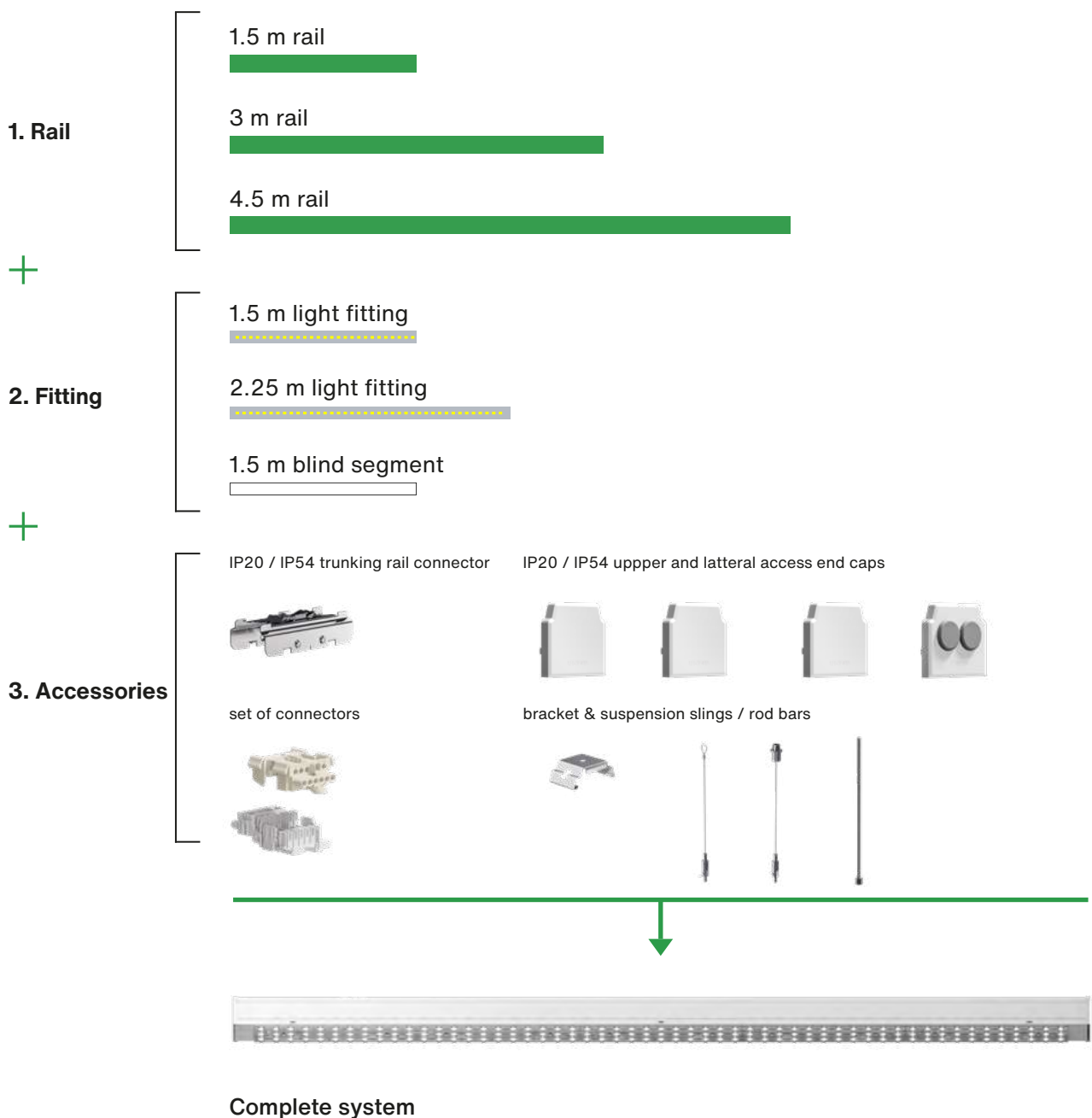

Flexibility in planning thanks to various lengths

The different lengths of both the GranVia luminaire and rails offers maximum adaptability: 1.5 m length luminaire for more flexibility in planning and adapting for smaller spaces and blind segments, and

2.25 m luminaires for use in cost-efficient projects. Together with three different lengths of rails, GranVia offers a variety of combinations for short, medium and long lines in different spaces.

Combinations covering short, middle and long dimensions



Example ①

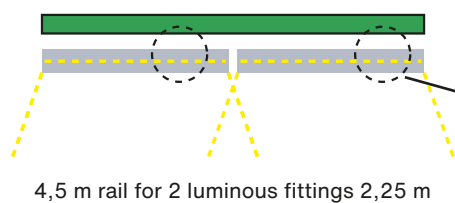

Example ②

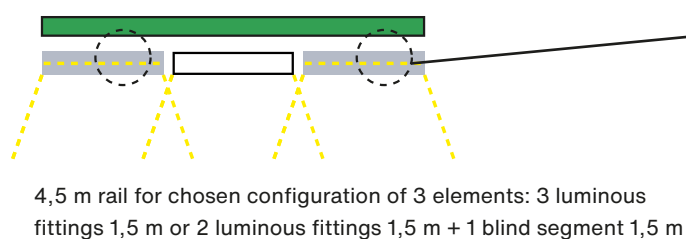

Luminaire is designed to be easily placed in the rail, thanks to built-in connectors.

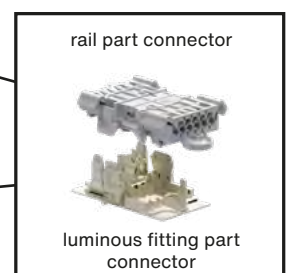

Included built-in connector for electrical connection of luminous fitting with rail.

Wide range of light distribution

GranVia ensures the highest performance and uniform illumination across industrial and retail areas. With a range of 12 light distributions - 8 available in the IP20 version and 4 in the IP54 version – each optimised to deliver optimal illumination tailored to specific applications, ensuring uncompromising visual comfort and functionality.

IP20

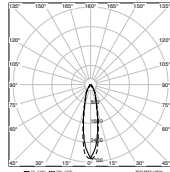

Narrow

The Narrow Beam optic provides uniform, efficient lighting for the vertical fronts of shelves. The illuminance levels are optimised for medium to high shelving with an emphasis on the aisle zones.

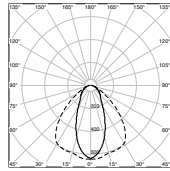
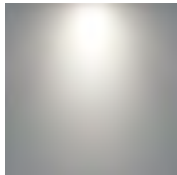

Oval

Solution for high-bay warehouses. It allows for greater distances between luminaires and ensures uniform lighting both on the floor and shelves.

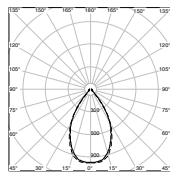
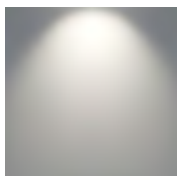

Medium

The optic ensures uniform and efficient lighting optimised for medium to high shelving, emphasising both the aisle zones and shelf surfaces.

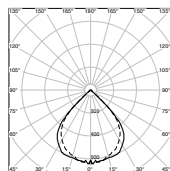
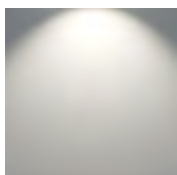

Flood

Provides uniform illumination allowing for easy relocation of industrial equipment. Retailers also benefit from greater flexibility, as shelves and display areas can be repositioned without rearranging the luminaires.

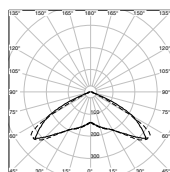

Super flood

It is designed for illuminating open retail and industrial spaces. In retail settings, it provides intense and uniform lighting for special offer sales areas, as well as for walkways and shelving in wide aisles.

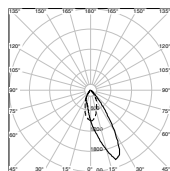
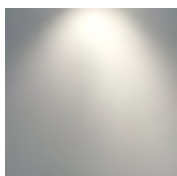

Asy

The asymmetrical light distribution is tailored specifically for lighting areas featuring shelving on one side only. In retail spaces the light directs customers' attention directly to products.

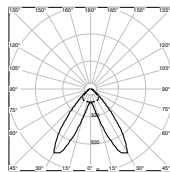
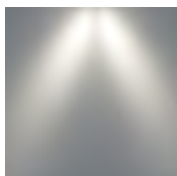

Double asy

It is ideal for use in areas with shelving on both sides. The double asymmetrical light distribution focuses the light on the shelving, while walkways are lit less, directing attention to the presentation of the goods.

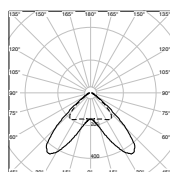
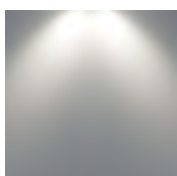

Double asy wide

Ideal for high-bay warehouses, this lighting is perfect for illuminating shelves on both sides of walkways, with less light directed to the floor. It provides better shelf illumination, especially in the case of greater distances between storage racks.

IP54

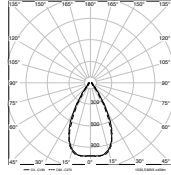
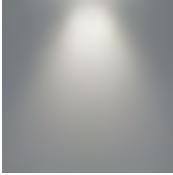

Medium

The optic ensures uniform and efficient lighting optimised for medium to high shelving, emphasising both the aisle zones and shelf surfaces.

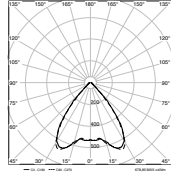
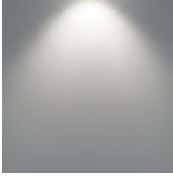

Flood

Provides uniform illumination allowing for easy relocation of industrial equipment. Retailers also benefit from greater flexibility, as shelves and display areas can be repositioned without rearranging the luminaires.

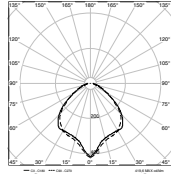
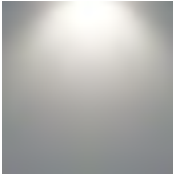

Wideflood

It is designed for illuminating open retail and industrial spaces. In retail settings, it provides intense and uniform lighting for special offer sales areas, as well as for walkways and shelving in wide aisles.

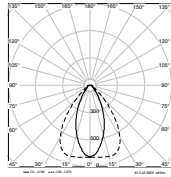
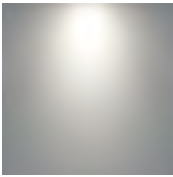

Oval

The Narrow Beam optic provides uniform, efficient lighting for the vertical fronts of shelves. The illuminance levels are optimised for medium to high shelving with an emphasis on the aisle zones.

Easy wire connection

Regular 3 lines supply, (5 wires)

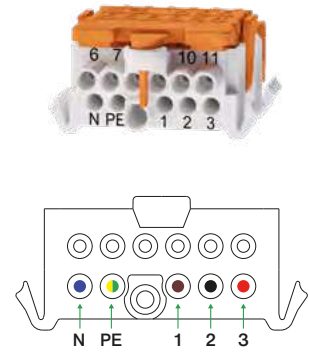
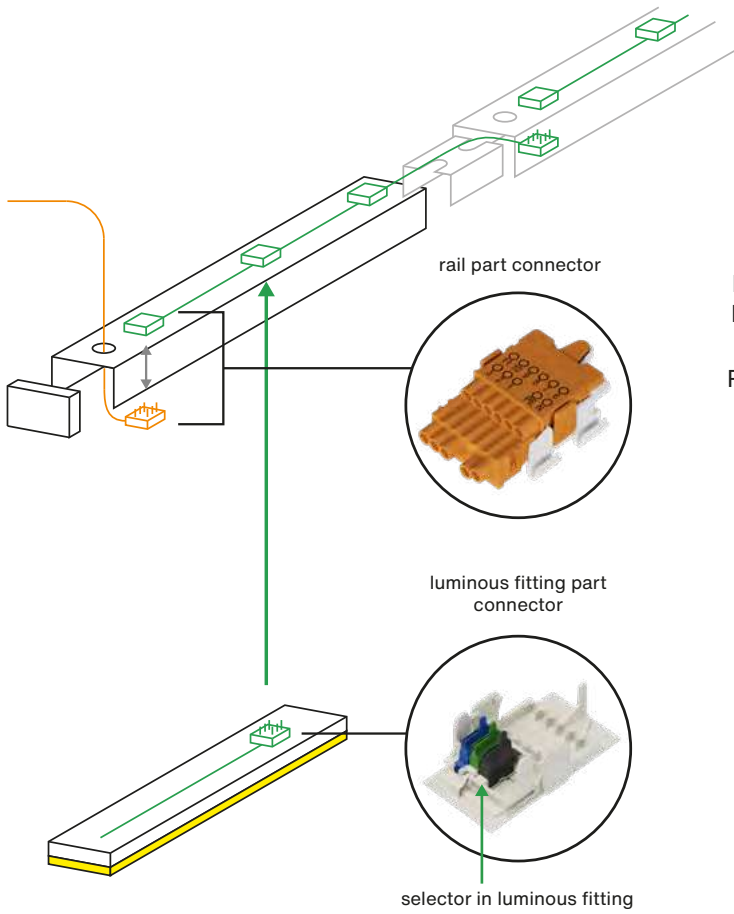

When installing, by moving the selector in each luminous fitting, different lines, (L1, L2 or L3) will be connected:

- Black selector beside green selector: luminaire is supplied from L3
- Black selector with one free space to green selector: luminaire is supplied from L2
- Black selector with two free spaces to green selector: luminaire is supplied from L1

Equivalent electric & control circuit:

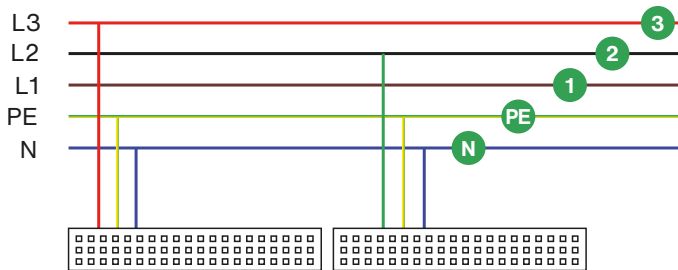

At the example two consecutive segments of trunking line are connected in two different lines to achieve equilibration of consumption or differentiation of lines.

Regular 3 lines supply with DALI control, (7 wires)

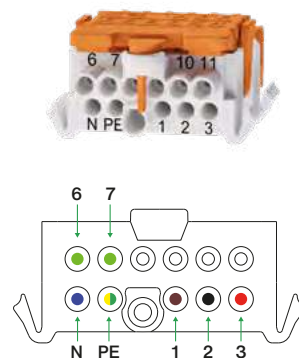
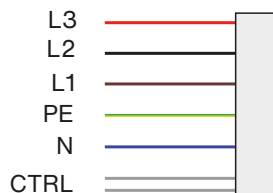
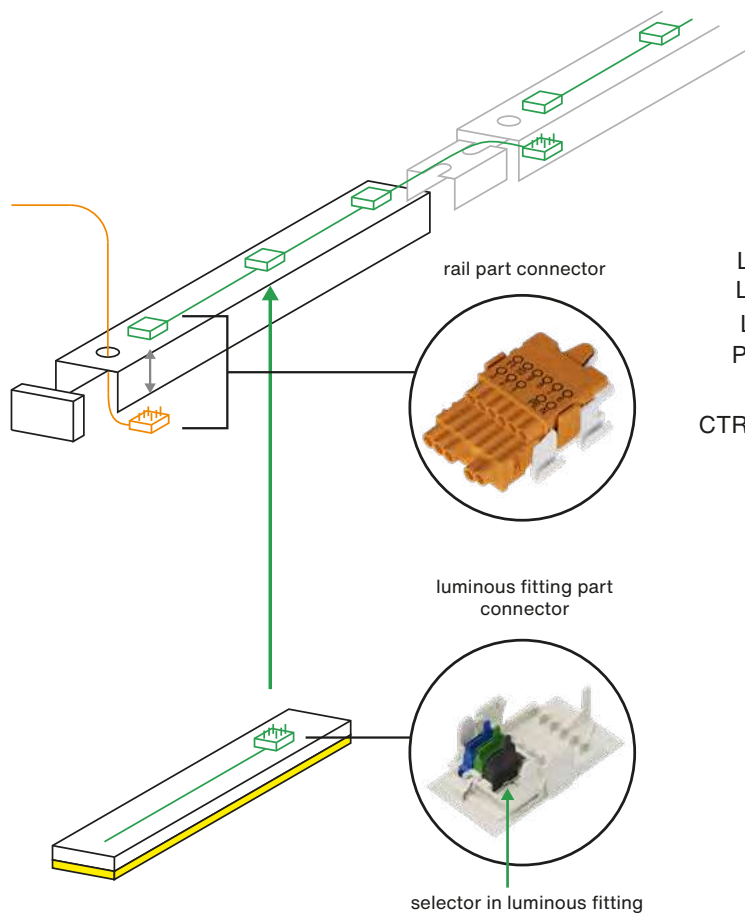

When installing, by moving the selector in each luminous fitting, different lines, (L1, L2 or L3) will be connected:

- Black selector beside green selector: luminaire is supplied from L3
- Black selector with one free space to green selector: luminaire is supplied from L2
- Black selector with two free spaces to green selector: luminaire is supplied from L1

Equivalent electric & control circuit:

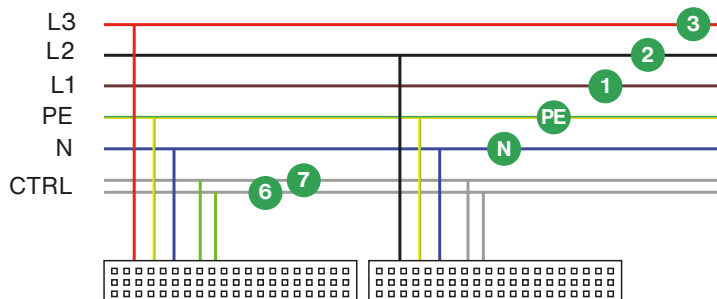

At the example two consecutive segments of trunking line are connected in the same line and also connected to the same DALI bus.

Regular 3 lines supply and special dedicated emergency lighting line, (7 wires)

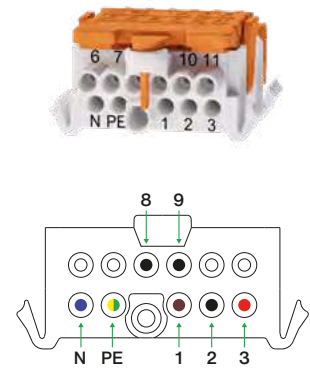
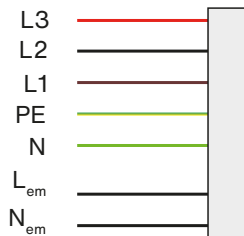
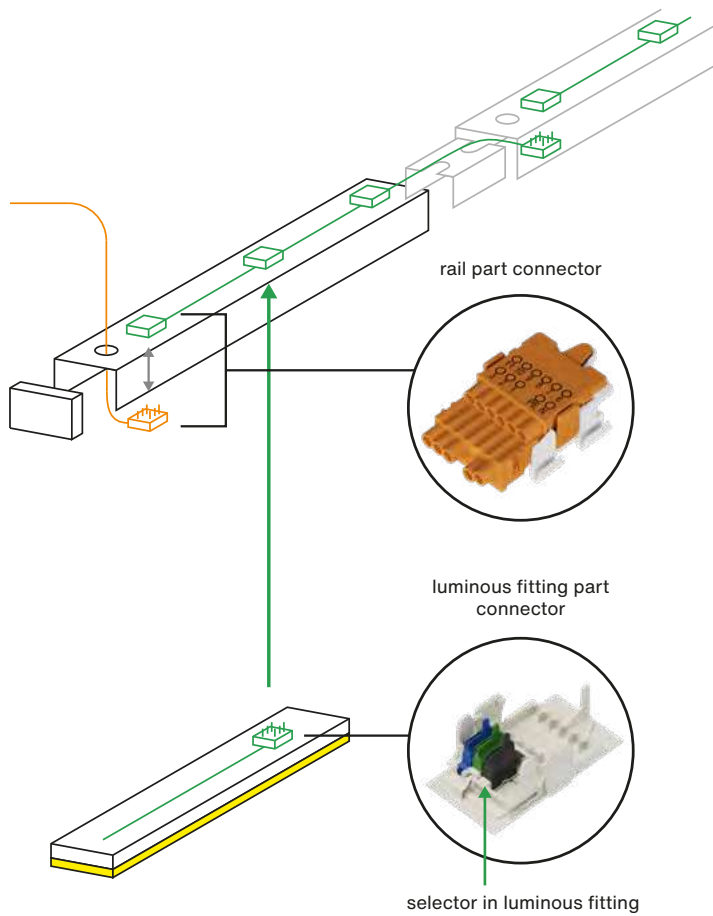

When installing, by moving the selector in each luminous fitting, different lines, (L1, L2 or L3) will be connected:

- Black selector beside green selector: luminaire is supplied from L3
- Black selector with one free space to green selector: luminaire is supplied from L2
- Black selector with two free spaces to green selector: luminaire is supplied from L1

Equivalent electric & control circuit:

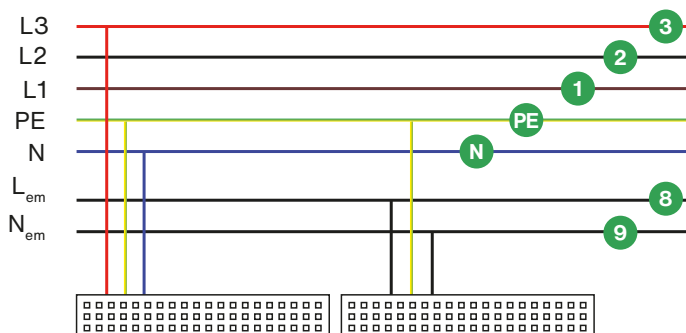

At the example a luminaire inserted in a trunking segment is connected to a regular supply line and the consecutive luminaire inserted in the consecutive trunking segment is connected to a line that is dedicated, (headed) to a emergency supply.

Regular 3 lines supply with DALI control and special dedicated emergency lighting line, (9 wires)

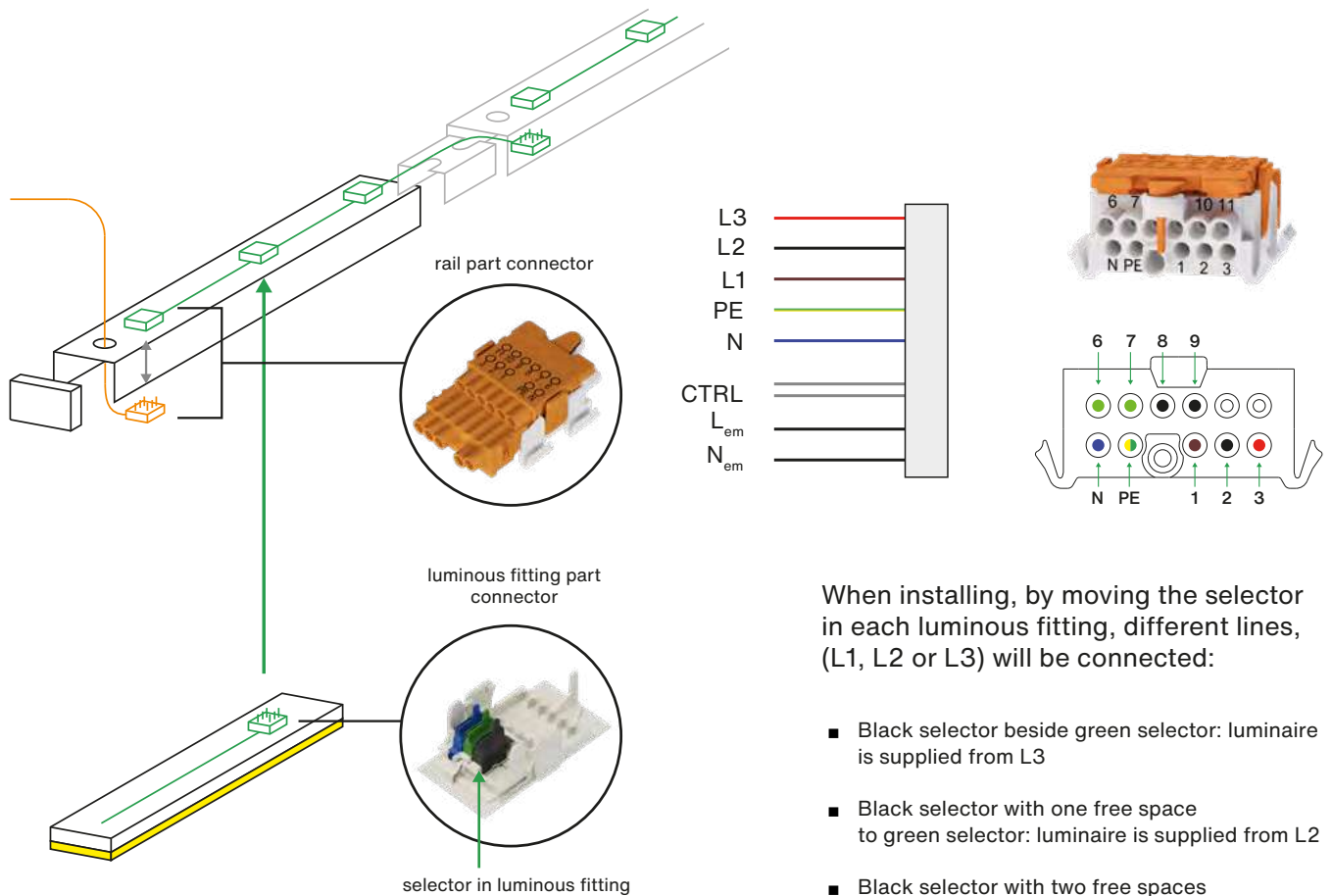

When installing, by moving the selector in each luminous fitting, different lines, (L1, L2 or L3) will be connected:

- Black selector beside green selector: luminaire is supplied from L3
- Black selector with one free space to green selector: luminaire is supplied from L2
- Black selector with two free spaces to green selector: luminaire is supplied from L1

Equivalent electric & control circuit:

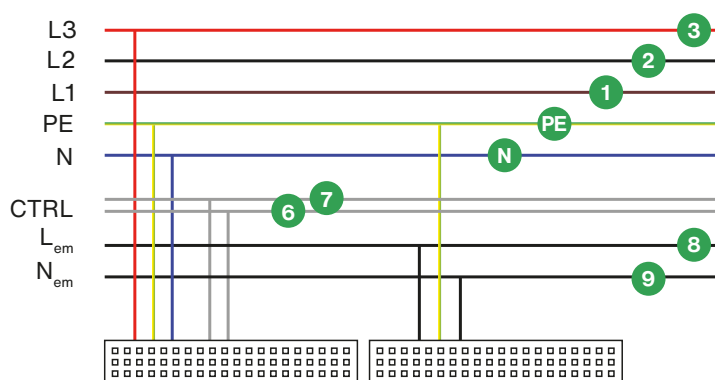

At the example a luminaire inserted in a trunking segment is connected to a regular supply line and to a DALI control bus and the consecutive luminaire inserted in the consecutive trunking segment is connected to a line that is dedicated, (headed) to a emergency supply.

Regular 3 lines supply with DALI control and special dedicated emergency lighting line with DALI control, (11 wires)

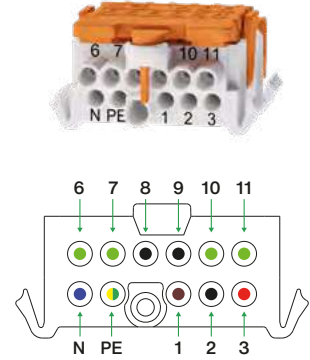
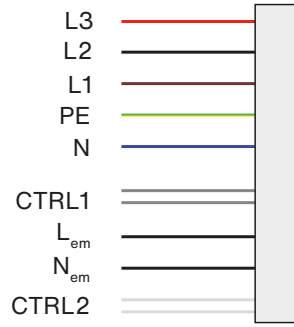
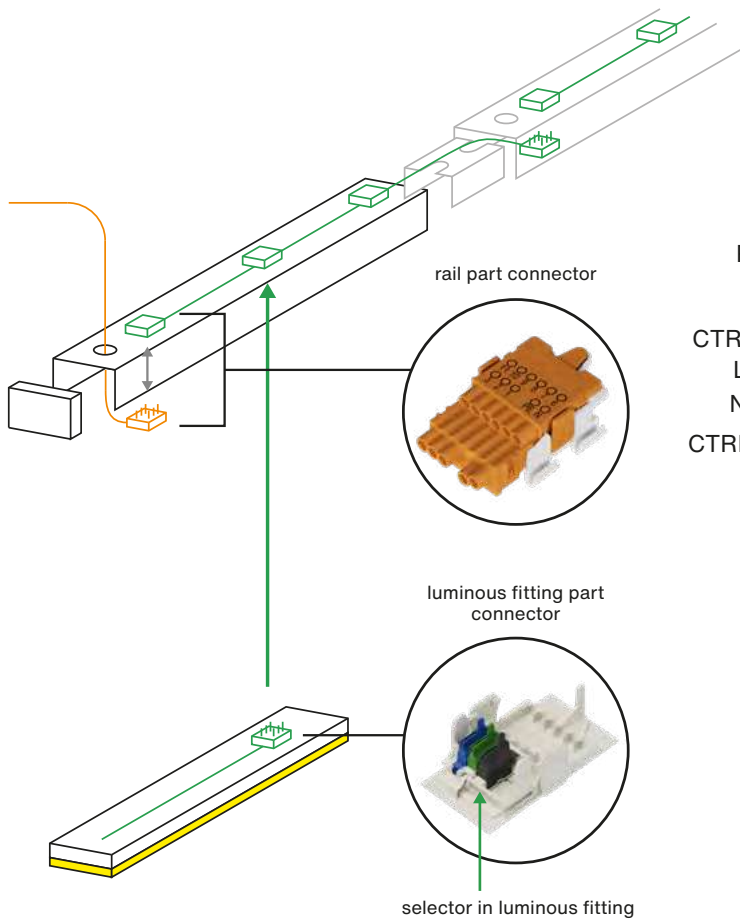

When installing, by moving the selector in each luminous fitting, different lines, (L1, L2 or L3) will be connected:

- Black selector beside green selector: luminaire is supplied from L3
- Black selector with one free space to green selector: luminaire is supplied from L2
- Black selector with two free spaces to green selector: luminaire is supplied from L1

Equivalent electric & control circuit:

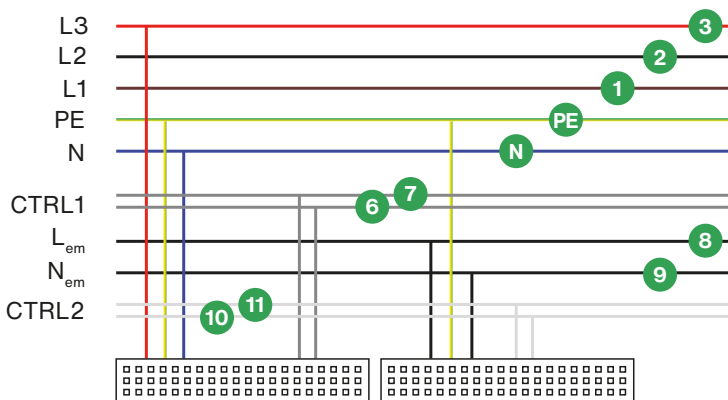

At the example a luminaire inserted in a trunking segment is connected to a regular supply line and to a DALI control bus and the consecutive luminaire inserted in the consecutive trunking segment is connected to a line that is dedicated, (headed) to a emergency supply which also is controlled by a different DALI control bus.

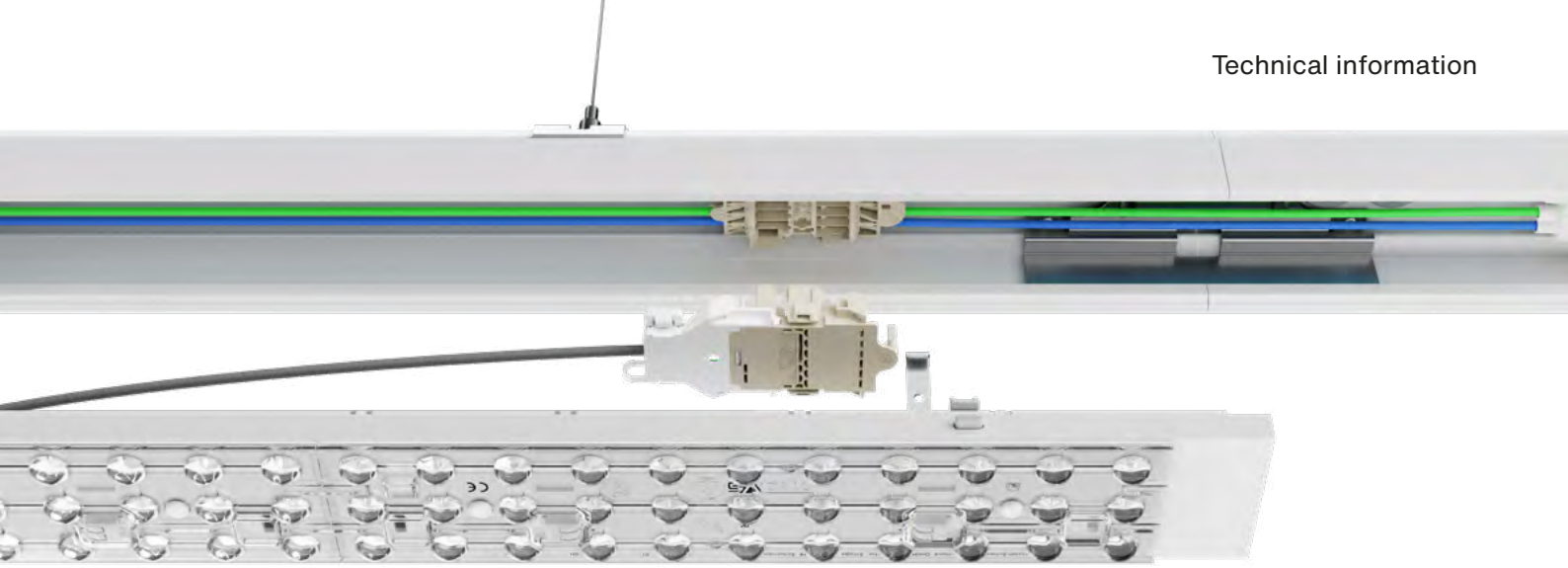

Accessories

Union
accessory
and power
& end
connectors

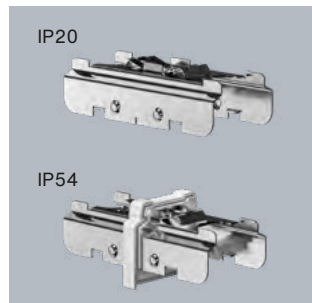

IP20 and IP54 rail
connectors



Set of power/end
connectors

The rail connector and power/end connectors allow to easily join multiple rails together to form continuous lines without tools. This enables quick installation and reduces mechanical connectivity time.

End caps



Upper access: set of 2
x blind end caps IP20



Upper access: set of
2 x blind end caps with
gaskets IP54

Endcaps to finish end of light lines are needed to ensure the IP20 or IP54 degrees of protection. End caps are available in two versions: with cable access from above (upper access) or with access from the lateral side of the luminaire (lateral access).



Lateral access: set of
blind end cap & end cap
with cable gland IP20



Lateral access: set
of blind end cap with
gaskets & end cap with
cable gland with gaskets
IP54

Brackets
& suspensions



Bracket



Suspension
sling accessory



Suspension rod
accessory

For those situations in which a suspended installation is required, specific suspensions are available in slings or even rod bars.



GRANVIA & GRANVIA PRO TRUNKING RAIL

Part of the versatile GRANVIA linear lighting system, the rail offers easy, tool-free installation in various lengths for maximum flexibility and efficiency. Made from premium Arcelor Mittal steel, it suits industrial and commercial use.

The trunking rail, that is a part of the GRANVIA linear lighting system is designed for surface-mounted or suspended installation. The rail is available in three lengths for greater flexibility: 1.5m, 3m and 4.5m. The connection between the two rails is made without tools, which, together with the long dimensions, minimises installation time for installers. It is a top-quality steel profile (Arcelor Mittal), which guarantees its protection in industrial and commercial spaces. The rail is available in 4 wiring options (5, 7, 9 and 11 wires), which allow the connection of three phases to system components equipped with a traditional on/off driver, and the possibility of connecting components equipped with a DALI driver, emergency system, sensors, etc.

Consult us for custom made versions.

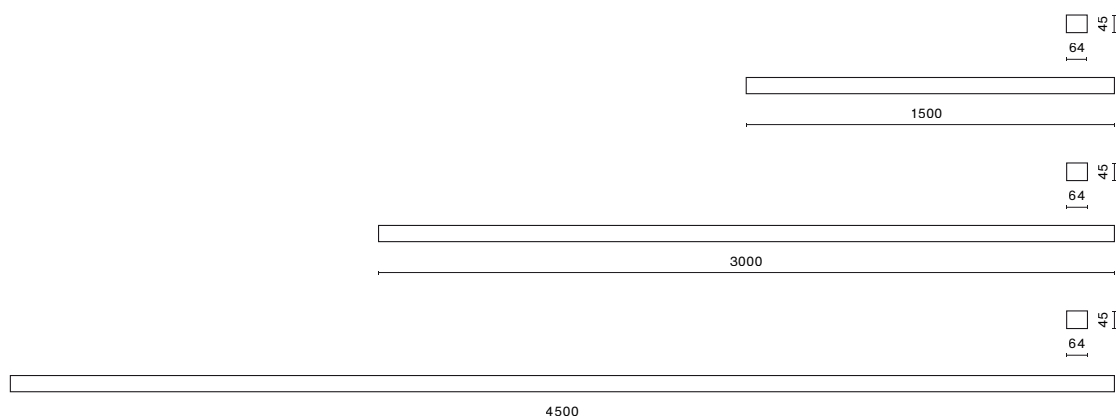

Specifications are subject to change. Pictures of the luminaires may differ from reality.
 In accordance to EN13032: luminous flux tolerance +/- 10% and power tolerance +/- 10%. Find out more at luxiona.com

GRANVIA & GRANVIA PRO TRUNKING RAIL



Rail length (mm)	To be connected to	Regular supply	Ready for emergency supply	Wires	Sales index
1500	1 x 1,5 m length lighting modules or 1 x 1,5 m blind segment	ON-OFF		5	19.4377.0009.34
			YES, on-off mode	7	19.4377.0034.34
		DALI		7	19.4377.0010.34
			YES, on-off mode	9	19.4377.0011.34
			YES, DALI mode	11	19.4377.0012.34
3000	2 x 1,5 m length lighting modules or 2 x 1,5 m blind segments or 1 x 1,5 m length lighting module + 1 x 1,5 m blind segment	ON-OFF		5	19.4377.0005.34
			YES, on-off mode	7	19.4377.0033.34
		DALI		7	19.4377.0006.34
			YES, on-off mode	9	19.4377.0007.34
			YES, DALI mode	11	19.4377.0008.34
4500	3 x 1,5 m length lighting modules or 1 x 1,5 m blind segment + 2 x 1,5 m lighting modules or 2 x 1,5 m blind segments + 1 x 1,5 m lighting module	ON-OFF		5	19.4377.0022.34
			YES, on-off mode	7	19.4377.0032.34
		DALI		7	19.4377.0023.34
			YES, on-off mode	9	19.4377.0024.34
			YES, DALI mode	11	19.4377.0025.34
	2 x 2,25 m length lighting modules	ON-OFF		5	19.4377.0001.34
			YES, on-off mode	7	19.4377.0031.34
		DALI		7	19.4377.0002.34
YES, on-off mode	9		19.4377.0003.34		
		YES, DALI mode	11	19.4377.0004.34	

Light and electrical features

Voltage 220..240 V, 50..60 Hz

Mechanical features

Material steel sheet
Colour RAL 9016 (white)
Assembly directly mounted to ceiling construction or surface mounted on slings using accessories

Specifications are subject to change. Pictures of the luminaires may differ from reality.
 In accordance to EN13032: luminous flux tolerance +/- 10% and power tolerance +/- 10%. Find out more at luxiona.com



GRANVIA PRO - LUMINOUS FITTINGS

Light distribution

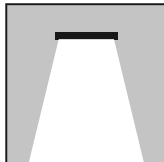

Advanced energy-efficient linear luminaire, perfect for industrial, warehouse, and commercial spaces. With a luminous efficiency up to 194 lm/W, it maximizes performance while minimizing energy use. The tool-less installation makes it quick and easy to create long lines of light, easily adjustable thanks to various versions and customisation options.

A cutting-edge energy-efficient linear luminaire, designed to deliver exceptional lighting performance for industrial, warehouse, and commercial spaces. With an impressive luminous efficiency up to 194 lm/W, this advanced lighting system ensures maximum performance while minimizing energy consumption. Installation is tool-less, making the process easy and quick, allowing you to create long lines of light with minimal effort. This luminaire is a perfect solution for supermarkets, large warehouses, and other retail and industrial spaces, offering efficient and sustainable illumination tailored to specific needs. Luminaire is available with 12 different light distributions, IP20 and IP54 version as well as with an option of customised body colour, colour temperature and CRI to match exact needs of most demanding projects.

Consult us for custom made versions.

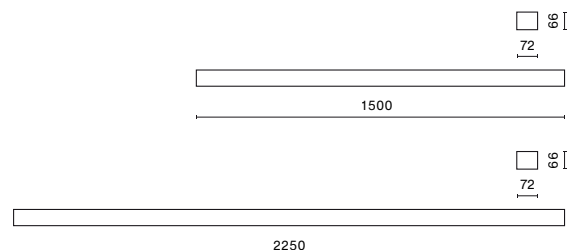

Luminous fittings sales indexes - pages: 34-37
 Blind segment 1,5 m IP20 index: 19.4377.0017.34
 Blind segment 1,5 m IP54 index: 19.4377.0021.34

Specifications are subject to change. Pictures of the luminaires may differ from reality.
 In accordance to EN13032: luminous flux tolerance +/- 10% and power tolerance +/- 10%. Find out more at luxiona.com

GRANVIA PRO - LUMINOUS FITTINGS



Light and electrical features

Light source	LED
Voltage	220..240 V, 50..60 Hz
Driver	standard on/off (E) / DIM DALI (EDD)
Operating temperature range [°C]	-20 ÷ 35
Power of luminaire [W]	31.7-172.7
Luminaire's light efficiency [lm/W]	145.2 - 193.9
Lifetime of LED sources [h]	100000
Lx/By	L80/B10
SDCM (LED sources)	3
Protection against electric shock I	
Photobiological risk class (IEC/EN 62471)	RG0
Light distribution	Direct (I-down) flood - 60° ÷ 90°, wideflood - 90° ÷ 120°, medium - 35° ÷ 60°, asymmetric, narrow - 15° ÷ 35°, superflood - over 120°
Beam	
Luminous flux LED [lm]	5977.3 - 28739.7

Mechanical features

Assembly	directly mounted to ceiling construction or surface mounted on slings
Material	steel sheet
Colour	RAL 9016 (white)

IP20

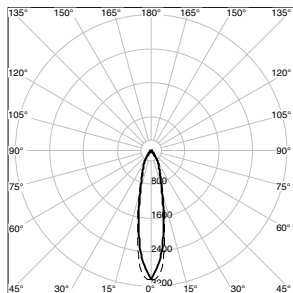

Narrow

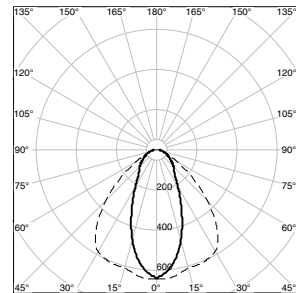

Oval

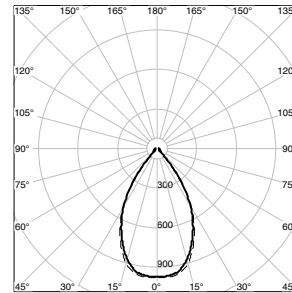

Medium

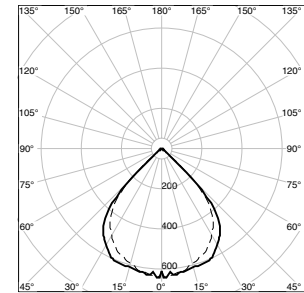

Flood

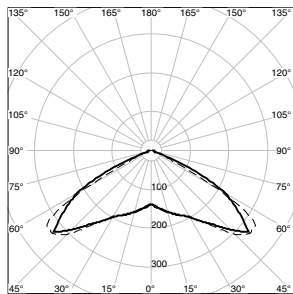

Super flood

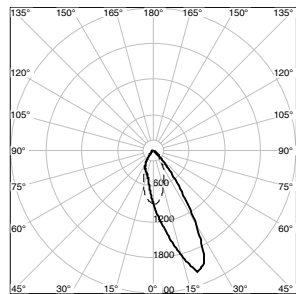

Asy

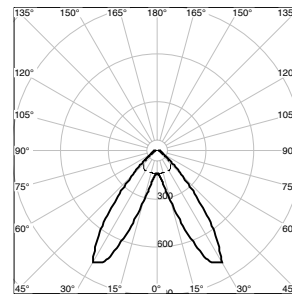

Double asy

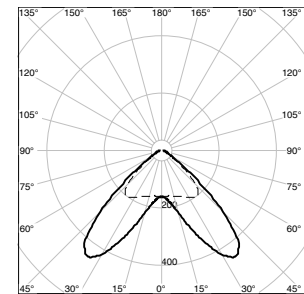

Double asy wide

IP54

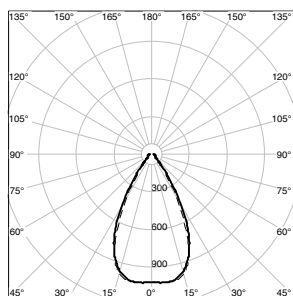

Medium

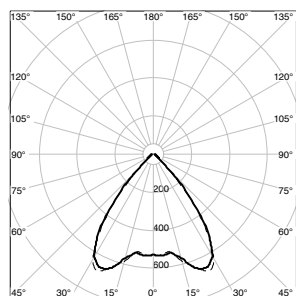

Flood

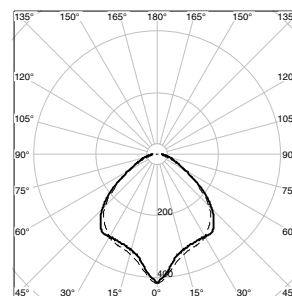

Wideflood

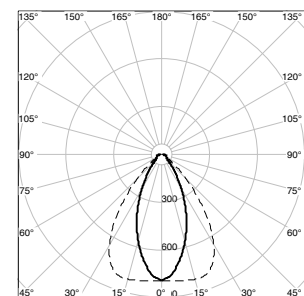

Oval

Specifications are subject to change. Pictures of the luminaires may differ from reality.
In accordance to EN13032: luminous flux tolerance +/- 10% and power tolerance +/- 10%. Find out more at luxiona.com

GranVia Pro selection guide

IP
20

4000K

100000h
L80/B10

4000K GranVia Pro LUMINOUS FITTINGS @ 100 000h L80 IP20

Length mm	2250								
W	173	146	119	98	80	68	56	44	
Lm range	26389 up to 27842	22999 up to 24265	19461 up to 20533	16718 up to 17639	13905 up to 14671	11993 up to 12653	10054 up to 10607	8088 up to 8534	
Lm/W max	161	167	172	180	184	187	190	193	
ON / OFF	Asy	19.4378.1G21.34	19.4378.1F21.34	19.4378.1E21.34	19.4378.1D21.34	19.4378.1C21.34	19.4378.1B21.34	19.4378.1A21.34	19.4378.1921.34
	Double asy	19.4378.2G21.34	19.4378.2F21.34	19.4378.2E21.34	19.4378.2D21.34	19.4378.2C21.34	19.4378.2B21.34	19.4378.2A21.34	19.4378.2921.34
	Double asy wide	19.4378.3G21.34	19.4378.3F21.34	19.4378.3E21.34	19.4378.3D21.34	19.4378.3C21.34	19.4378.3B21.34	19.4378.3A21.34	19.4378.3921.34
	Oval	19.4378.6G21.34	19.4378.6F21.34	19.4378.6E21.34	19.4378.6D21.34	19.4378.6C21.34	19.4378.6B21.34	19.4378.6A21.34	19.4378.6921.34
	Super flood	19.4378.7G21.34	19.4378.7F21.34	19.4378.7E21.34	19.4378.7D21.34	19.4378.7C21.34	19.4378.7B21.34	19.4378.7A21.34	19.4378.7921.34
	Flood	19.4378.8G21.34	19.4378.8F21.34	19.4378.8E21.34	19.4378.8D21.34	19.4378.8C21.34	19.4378.8B21.34	19.4378.8A21.34	19.4378.8921.34
	Medium	19.4378.4G21.34	19.4378.4F21.34	19.4378.4E21.34	19.4378.4D21.34	19.4378.4C21.34	19.4378.4B21.34	19.4378.4A21.34	19.4378.4921.34
	Narrow	19.4378.5G21.34	19.4378.5F21.34	19.4378.5E21.34	19.4378.5D21.34	19.4378.5C21.34	19.4378.5B21.34	19.4378.5A21.34	19.4378.5921.34
DALI	Asy	19.4378.1G23.34	19.4378.1F23.34	19.4378.1E23.34	19.4378.1D23.34	19.4378.1C23.34	19.4378.1B23.34	19.4378.1A23.34	19.4378.1923.34
	Double asy	19.4378.2G23.34	19.4378.2F23.34	19.4378.2E23.34	19.4378.2D23.34	19.4378.2C23.34	19.4378.2B23.34	19.4378.2A23.34	19.4378.2923.34
	Double asy wide	19.4378.3G23.34	19.4378.3F23.34	19.4378.3E23.34	19.4378.3D23.34	19.4378.3C23.34	19.4378.3B23.34	19.4378.3A23.34	19.4378.3923.34
	Oval	19.4378.6G23.34	19.4378.6F23.34	19.4378.6E23.34	19.4378.6D23.34	19.4378.6C23.34	19.4378.6B23.34	19.4378.6A23.34	19.4378.6923.34
	Super flood	19.4378.7G23.34	19.4378.7F23.34	19.4378.7E23.34	19.4378.7D23.34	19.4378.7C23.34	19.4378.7B23.34	19.4378.7A23.34	19.4378.7923.34
	Flood	19.4378.8G23.34	19.4378.8F23.34	19.4378.8E23.34	19.4378.8D23.34	19.4378.8C23.34	19.4378.8B23.34	19.4378.8A23.34	19.4378.8923.34
	Medium	19.4378.4G23.34	19.4378.4F23.34	19.4378.4E23.34	19.4378.4D23.34	19.4378.4C23.34	19.4378.4B23.34	19.4378.4A23.34	19.4378.4923.34
	Narrow	19.4378.5G23.34	19.4378.5F23.34	19.4378.5E23.34	19.4378.5D23.34	19.4378.5C23.34	19.4378.5B23.34	19.4378.5A23.34	19.4378.5923.34

Length mm	1500								
W	123	104	83	70	57	48	40	32	
Lm range	18849 up to 19887	16428 up to 17332	13901 up to 14666	11942 up to 12599	9932 up to 10479	8566 up to 9038	7181 up to 7577	5777 up to 6095	
Lm/W max	161	167	176	180	184	187	190	192	
ON / OFF	Asy	19.4378.1821.34	19.4378.1721.34	19.4378.1621.34	19.4378.1521.34	19.4378.1421.34	19.4378.1321.34	19.4378.1221.34	19.4378.1121.34
	Double asy	19.4378.2821.34	19.4378.2721.34	19.4378.2621.34	19.4378.2521.34	19.4378.2421.34	19.4378.2321.34	19.4378.2221.34	19.4378.2121.34
	Double asy wide	19.4378.3821.34	19.4378.3721.34	19.4378.3621.34	19.4378.3521.34	19.4378.3421.34	19.4378.3321.34	19.4378.3221.34	19.4378.3121.34
	Oval	19.4378.6821.34	19.4378.6721.34	19.4378.6621.34	19.4378.6521.34	19.4378.6421.34	19.4378.6321.34	19.4378.6221.34	19.4378.6121.34
	Super flood	19.4378.7821.34	19.4378.7721.34	19.4378.7621.34	19.4378.7521.34	19.4378.7421.34	19.4378.7321.34	19.4378.7221.34	19.4378.7121.34
	Flood	19.4378.8821.34	19.4378.8721.34	19.4378.8621.34	19.4378.8521.34	19.4378.8421.34	19.4378.8321.34	19.4378.8221.34	19.4378.8121.34
	Medium	19.4378.4821.34	19.4378.4721.34	19.4378.4621.34	19.4378.4521.34	19.4378.4421.34	19.4378.4321.34	19.4378.4221.34	19.4378.4121.34
	Narrow	19.4378.5821.34	19.4378.5721.34	19.4378.5621.34	19.4378.5521.34	19.4378.5421.34	19.4378.5321.34	19.4378.5221.34	19.4378.5121.34
DALI	Asy	19.4378.1823.34	19.4378.1723.34	19.4378.1623.34	19.4378.1523.34	19.4378.1423.34	19.4378.1323.34	19.4378.1223.34	19.4378.1123.34
	Double asy	19.4378.2823.34	19.4378.2723.34	19.4378.2623.34	19.4378.2523.34	19.4378.2423.34	19.4378.2323.34	19.4378.2223.34	19.4378.2123.34
	Double asy wide	19.4378.3823.34	19.4378.3723.34	19.4378.3623.34	19.4378.3523.34	19.4378.3423.34	19.4378.3323.34	19.4378.3223.34	19.4378.3123.34
	Oval	19.4378.6823.34	19.4378.6723.34	19.4378.6623.34	19.4378.6523.34	19.4378.6423.34	19.4378.6323.34	19.4378.6223.34	19.4378.6123.34
	Super flood	19.4378.7823.34	19.4378.7723.34	19.4378.7623.34	19.4378.7523.34	19.4378.7423.34	19.4378.7323.34	19.4378.7223.34	19.4378.7123.34
	Flood	19.4378.8823.34	19.4378.8723.34	19.4378.8623.34	19.4378.8523.34	19.4378.8423.34	19.4378.8323.34	19.4378.8223.34	19.4378.8123.34
	Medium	19.4378.4823.34	19.4378.4723.34	19.4378.4623.34	19.4378.4523.34	19.4378.4423.34	19.4378.4323.34	19.4378.4223.34	19.4378.4123.34
	Narrow	19.4378.5823.34	19.4378.5723.34	19.4378.5623.34	19.4378.5523.34	19.4378.5423.34	19.4378.5323.34	19.4378.5223.34	19.4378.5123.34

IP 20	3000K	100000h L80/B10
----------	-------	--------------------

3000K GranVia Pro LUMINOUS FITTINGS @ 100 000h L80 IP20

Length mm		2250							
W	173	146	119	98	80	68	56	44	
Lm range	25069 up to 26450	21849 up to 23052	18488 up to 19506	15882 up to 16757	13210 up to 13937	11393 up to 12021	9551 up to 10077	7684 up to 8107	
Lm/W max	149	154	159	166	170	173	175	178	
ON / OFF	Asy	19.4378.1G11.34	19.4378.1F11.34	19.4378.1E11.34	19.4378.1D11.34	19.4378.1C11.34	19.4378.1B11.34	19.4378.1A11.34	19.4378.1911.34
	Double asy	19.4378.2G11.34	19.4378.2F11.34	19.4378.2E11.34	19.4378.2D11.34	19.4378.2C11.34	19.4378.2B11.34	19.4378.2A11.34	19.4378.2911.34
	Double asy wide	19.4378.3G11.34	19.4378.3F11.34	19.4378.3E11.34	19.4378.3D11.34	19.4378.3C11.34	19.4378.3B11.34	19.4378.3A11.34	19.4378.3911.34
	Oval	19.4378.6G11.34	19.4378.6F11.34	19.4378.6E11.34	19.4378.6D11.34	19.4378.6C11.34	19.4378.6B11.34	19.4378.6A11.34	19.4378.6911.34
	Super flood	19.4378.7G11.34	19.4378.7F11.34	19.4378.7E11.34	19.4378.7D11.34	19.4378.7C11.34	19.4378.7B11.34	19.4378.7A11.34	19.4378.7911.34
	Flood	19.4378.8G11.34	19.4378.8F11.34	19.4378.8E11.34	19.4378.8D11.34	19.4378.8C11.34	19.4378.8B11.34	19.4378.8A11.34	19.4378.8911.34
	Medium	19.4378.4G11.34	19.4378.4F11.34	19.4378.4E11.34	19.4378.4D11.34	19.4378.4C11.34	19.4378.4B11.34	19.4378.4A11.34	19.4378.4911.34
	Narrow	19.4378.5G11.34	19.4378.5F11.34	19.4378.5E11.34	19.4378.5D11.34	19.4378.5C11.34	19.4378.5B11.34	19.4378.5A11.34	19.4378.5911.34
DALI	Asy	19.4378.1G13.34	19.4378.1F13.34	19.4378.1E13.34	19.4378.1D13.34	19.4378.1C13.34	19.4378.1B13.34	19.4378.1A13.34	19.4378.1913.34
	Double asy	19.4378.2G13.34	19.4378.2F13.34	19.4378.2E13.34	19.4378.2D13.34	19.4378.2C13.34	19.4378.2B13.34	19.4378.2A13.34	19.4378.2913.34
	Double asy wide	19.4378.3G13.34	19.4378.3F13.34	19.4378.3E13.34	19.4378.3D13.34	19.4378.3C13.34	19.4378.3B13.34	19.4378.3A13.34	19.4378.3913.34
	Oval	19.4378.6G13.34	19.4378.6F13.34	19.4378.6E13.34	19.4378.6D13.34	19.4378.6C13.34	19.4378.6B13.34	19.4378.6A13.34	19.4378.6913.34
	Super flood	19.4378.7G13.34	19.4378.7F13.34	19.4378.7E13.34	19.4378.7D13.34	19.4378.7C13.34	19.4378.7B13.34	19.4378.7A13.34	19.4378.7913.34
	Flood	19.4378.8G13.34	19.4378.8F13.34	19.4378.8E13.34	19.4378.8D13.34	19.4378.8C13.34	19.4378.8B13.34	19.4378.8A13.34	19.4378.8913.34
	Medium	19.4378.4G13.34	19.4378.4F13.34	19.4378.4E13.34	19.4378.4D13.34	19.4378.4C13.34	19.4378.4B13.34	19.4378.4A13.34	19.4378.4913.34
	Narrow	19.4378.5G13.34	19.4378.5F13.34	19.4378.5E13.34	19.4378.5D13.34	19.4378.5C13.34	19.4378.5B13.34	19.4378.5A13.34	19.4378.5913.34

Length mm		1500							
W	123	104	83	70	57	48	40	32	
Lm range	17907 up to 18893	15606 up to 16466	13206 up to 13933	11345 up to 11969	9436 up to 9955	8138 up to 8586	6822 up to 7198	5488 up to 5791	
Lm/W max	149	154	162	166	170	172	175	178	
ON / OFF	Asy	19.4378.1811.34	19.4378.1711.34	19.4378.1611.34	19.4378.1511.34	19.4378.1411.34	19.4378.1311.34	19.4378.1211.34	19.4378.1111.34
	Double asy	19.4378.2811.34	19.4378.2711.34	19.4378.2611.34	19.4378.2511.34	19.4378.2411.34	19.4378.2311.34	19.4378.2211.34	19.4378.2111.34
	Double asy wide	19.4378.3811.34	19.4378.3711.34	19.4378.3611.34	19.4378.3511.34	19.4378.3411.34	19.4378.3311.34	19.4378.3211.34	19.4378.3111.34
	Oval	19.4378.6811.34	19.4378.6711.34	19.4378.6611.34	19.4378.6511.34	19.4378.6411.34	19.4378.6311.34	19.4378.6211.34	19.4378.6111.34
	Super flood	19.4378.7811.34	19.4378.7711.34	19.4378.7611.34	19.4378.7511.34	19.4378.7411.34	19.4378.7311.34	19.4378.7211.34	19.4378.7111.34
	Flood	19.4378.8811.34	19.4378.8711.34	19.4378.8611.34	19.4378.8511.34	19.4378.8411.34	19.4378.8311.34	19.4378.8211.34	19.4378.8111.34
	Medium	19.4378.4811.34	19.4378.4711.34	19.4378.4611.34	19.4378.4511.34	19.4378.4411.34	19.4378.4311.34	19.4378.4211.34	19.4378.4111.34
	Narrow	19.4378.5811.34	19.4378.5711.34	19.4378.5611.34	19.4378.5511.34	19.4378.5411.34	19.4378.5311.34	19.4378.5211.34	19.4378.5111.34
DALI	Asy	19.4378.1813.34	19.4378.1713.34	19.4378.1613.34	19.4378.1513.34	19.4378.1413.34	19.4378.1313.34	19.4378.1213.34	19.4378.1113.34
	Double asy	19.4378.2813.34	19.4378.2713.34	19.4378.2613.34	19.4378.2513.34	19.4378.2413.34	19.4378.2313.34	19.4378.2213.34	19.4378.2113.34
	Double asy wide	19.4378.3813.34	19.4378.3713.34	19.4378.3613.34	19.4378.3513.34	19.4378.3413.34	19.4378.3313.34	19.4378.3213.34	19.4378.3113.34
	Oval	19.4378.6813.34	19.4378.6713.34	19.4378.6613.34	19.4378.6513.34	19.4378.6413.34	19.4378.6313.34	19.4378.6213.34	19.4378.6113.34
	Super flood	19.4378.7813.34	19.4378.7713.34	19.4378.7613.34	19.4378.7513.34	19.4378.7413.34	19.4378.7313.34	19.4378.7213.34	19.4378.7113.34
	Flood	19.4378.8813.34	19.4378.8713.34	19.4378.8613.34	19.4378.8513.34	19.4378.8413.34	19.4378.8313.34	19.4378.8213.34	19.4378.8113.34
	Medium	19.4378.4813.34	19.4378.4713.34	19.4378.4613.34	19.4378.4513.34	19.4378.4413.34	19.4378.4313.34	19.4378.4213.34	19.4378.4113.34
	Narrow	19.4378.5813.34	19.4378.5713.34	19.4378.5613.34	19.4378.5513.34	19.4378.5413.34	19.4378.5313.34	19.4378.5213.34	19.4378.5113.34

GranVia Pro selection guide

IP
54

4000K

100000h
L80/B10

4000K GranVia Pro LUMINOUS FITTINGS @ 100.000h L80 IP54

Length mm		2250							
W	173	146	119	98	80	68	56	44	
Lm range	27003 up to 28022	23534 up to 24422	19914 up to 20665	17107 up to 17753	14229 up to 14766	12272 up to 12735	10287 up to 10676	8276 up to 8589	
Lm/W max	162	168	173	181	185	188	191	194	
ON / OFF	Wideflood	19.4381.3G21.34	19.4381.3F21.34	19.4381.3E21.34	19.4381.3D21.34	19.4381.3C21.34	19.4381.3B21.34	19.4381.3A21.34	19.4381.3921.34
	Flood	19.4381.4G21.34	19.4381.4F21.34	19.4381.4E21.34	19.4381.4D21.34	19.4381.4C21.34	19.4381.4B21.34	19.4381.4A21.34	19.4381.4921.34
	Oval	19.4381.2G21.34	19.4381.2F21.34	19.4381.2E21.34	19.4381.2D21.34	19.4381.2C21.34	19.4381.2B21.34	19.4381.2A21.34	19.4381.2921.34
	Medium	19.4381.1G21.34	19.4381.1F21.34	19.4381.1E21.34	19.4381.1D21.34	19.4381.1C21.34	19.4381.1B21.34	19.4381.1A21.34	19.4381.1921.34
DALI	Wideflood	19.4381.3G23.34	19.4381.3F23.34	19.4381.3E23.34	19.4381.3D23.34	19.4381.3C23.34	19.4381.3B23.34	19.4381.3A23.34	19.4381.3923.34
	Flood	19.4381.4G23.34	19.4381.4F23.34	19.4381.4E23.34	19.4381.4D23.34	19.4381.4C23.34	19.4381.4B23.34	19.4381.4A23.34	19.4381.4923.34
	Oval	19.4381.2G23.34	19.4381.2F23.34	19.4381.2E23.34	19.4381.2D23.34	19.4381.2C23.34	19.4381.2B23.34	19.4381.2A23.34	19.4381.2923.34
	Medium	19.4381.1G23.34	19.4381.1F23.34	19.4381.1E23.34	19.4381.1D23.34	19.4381.1C23.34	19.4381.1B23.34	19.4381.1A23.34	19.4381.1923.34

Length mm		1500							
W	123	104	83	70	57	48	40	32	
Lm range	19288 up to 20016	16810 up to 17444	14224 up to 14761	12219 up to 12681	10163 up to 10547	8766 up to 9097	7348 up to 7626	5912 up to 6135	
Lm/W max	162	168	177	181	185	188	191	194	
ON / OFF	Wideflood	19.4381.3821.34	19.4381.3721.34	19.4381.3621.34	19.4381.3521.34	19.4381.3421.34	19.4381.3321.34	19.4381.3221.34	19.4381.3121.34
	Flood	19.4381.4821.34	19.4381.4721.34	19.4381.4621.34	19.4381.4521.34	19.4381.4421.34	19.4381.4321.34	19.4381.4221.34	19.4381.4121.34
	Oval	19.4381.2821.34	19.4381.2721.34	19.4381.2621.34	19.4381.2521.34	19.4381.2421.34	19.4381.2321.34	19.4381.2221.34	19.4381.2121.34
	Medium	19.4381.1821.34	19.4381.1721.34	19.4381.1621.34	19.4381.1521.34	19.4381.1421.34	19.4381.1321.34	19.4381.1221.34	19.4381.1121.34
DALI	Wideflood	19.4381.3823.34	19.4381.3723.34	19.4381.3623.34	19.4381.3523.34	19.4381.3423.34	19.4381.3323.34	19.4381.3223.34	19.4381.3123.34
	Flood	19.4381.4823.34	19.4381.4723.34	19.4381.4623.34	19.4381.4523.34	19.4381.4423.34	19.4381.4323.34	19.4381.4223.34	19.4381.4123.34
	Oval	19.4381.2823.34	19.4381.2723.34	19.4381.2623.34	19.4381.2523.34	19.4381.2423.34	19.4381.2323.34	19.4381.2223.34	19.4381.2123.34
	Medium	19.4381.1823.34	19.4381.1723.34	19.4381.1623.34	19.4381.1523.34	19.4381.1423.34	19.4381.1323.34	19.4381.1223.34	19.4381.1123.34

IP 54	3000K	100000h L80/B10
----------	-------	--------------------

3000K GranVia Pro LUMINOUS FITTINGS @ 100.000h L80 IP54

Length mm		2250							
W	173	146	119	98	80	68	56	44	
Lm range	25653 up to 26621	22357 up to 23201	18918 up to 19632	16252 up to 16865	13517 up to 14027	11658 up to 12099	9773 up to 10142	7863 up to 8159	
Lm/W max	154	159	165	172	176	179	181	184	
ON / OFF	Wideflood	19.4381.3G11.34	19.4381.3F11.34	19.4381.3E11.34	19.4381.3D11.34	19.4381.3C11.34	19.4381.3B11.34	19.4381.3A11.34	19.4381.3911.34
	Flood	19.4381.4G11.34	19.4381.4F11.34	19.4381.4E11.34	19.4381.4D11.34	19.4381.4C11.34	19.4381.4B11.34	19.4381.4A11.34	19.4381.4911.34
	Oval	19.4381.2G11.34	19.4381.2F11.34	19.4381.2E11.34	19.4381.2D11.34	19.4381.2C11.34	19.4381.2B11.34	19.4381.2A11.34	19.4381.2911.34
	Medium	19.4381.1G11.34	19.4381.1F11.34	19.4381.1E11.34	19.4381.1D11.34	19.4381.1C11.34	19.4381.1B11.34	19.4381.1A11.34	19.4381.1911.34
DALI	Wideflood	19.4381.3G13.34	19.4381.3F13.34	19.4381.3E13.34	19.4381.3D13.34	19.4381.3C13.34	19.4381.3B13.34	19.4381.3A13.34	19.4381.3913.34
	Flood	19.4381.4G13.34	19.4381.4F13.34	19.4381.4E13.34	19.4381.4D13.34	19.4381.4C13.34	19.4381.4B13.34	19.4381.4A13.34	19.4381.4913.34
	Oval	19.4381.2G13.34	19.4381.2F13.34	19.4381.2E13.34	19.4381.2D13.34	19.4381.2C13.34	19.4381.2B13.34	19.4381.2A13.34	19.4381.2913.34
	Medium	19.4381.1G13.34	19.4381.1F13.34	19.4381.1E13.34	19.4381.1D13.34	19.4381.1C13.34	19.4381.1B13.34	19.4381.1A13.34	19.4381.1913.34

Length mm		1500							
W	123	104	83	70	57	48	40	32	
Lm range	18323 up to 19015	15969 up to 16572	13513 up to 14023	11609 up to 12047	9655 up to 10020	8327 up to 8642	6981 up to 7244	5616 up to 5828	
Lm/W max	154	159	168	172	176	179	182	184	
ON / OFF	Wideflood	19.4381.3811.34	19.4381.3711.34	19.4381.3611.34	19.4381.3511.34	19.4381.3411.34	19.4381.3311.34	19.4381.3211.34	19.4381.3111.34
	Flood	19.4381.4811.34	19.4381.4711.34	19.4381.4611.34	19.4381.4511.34	19.4381.4411.34	19.4381.4311.34	19.4381.4211.34	19.4381.4111.34
	Oval	19.4381.2811.34	19.4381.2711.34	19.4381.2611.34	19.4381.2511.34	19.4381.2411.34	19.4381.2311.34	19.4381.2211.34	19.4381.2111.34
	Medium	19.4381.1811.34	19.4381.1711.34	19.4381.1611.34	19.4381.1511.34	19.4381.1411.34	19.4381.1311.34	19.4381.1211.34	19.4381.1111.34
DALI	Wideflood	19.4381.3813.34	19.4381.3713.34	19.4381.3613.34	19.4381.3513.34	19.4381.3413.34	19.4381.3313.34	19.4381.3213.34	19.4381.3113.34
	Flood	19.4381.4813.34	19.4381.4713.34	19.4381.4613.34	19.4381.4513.34	19.4381.4413.34	19.4381.4313.34	19.4381.4213.34	19.4381.4113.34
	Oval	19.4381.2813.34	19.4381.2713.34	19.4381.2613.34	19.4381.2513.34	19.4381.2413.34	19.4381.2313.34	19.4381.2213.34	19.4381.2113.34
	Medium	19.4381.1813.34	19.4381.1713.34	19.4381.1613.34	19.4381.1513.34	19.4381.1413.34	19.4381.1313.34	19.4381.1213.34	19.4381.1113.34



GRANVIA - STANDARD LUMINOUS FITTINGS

Light distribution

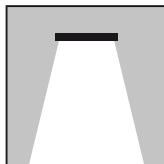

Advanced energy-efficient linear luminaire, perfect for industrial, warehouse, and commercial spaces. With a luminous efficiency up to 191 lm/W, it maximizes performance while minimizing energy use. The tool-less installation makes it quick and easy to create long lines of light, easily adjustable thanks to various versions and customisation options.

A cutting-edge energy-efficient linear luminaire, designed to deliver exceptional lighting performance for industrial, warehouse, and commercial spaces. With an impressive luminous efficiency up to 191 lm/W, this advanced lighting system ensures maximum performance while minimizing energy consumption. Installation is tool-less, making the process easy and quick, allowing you to create long lines of light with minimal effort. This luminaire is a perfect solution for supermarkets, large warehouses, and other retail and industrial spaces, offering efficient and sustainable illumination tailored to specific needs. Luminaire is available with 12 different light distributions, IP20 and IP54 version as well as with an option of customised body colour, colour temperature and CRI to match exact needs of most demanding projects.

Consult us for custom made versions.

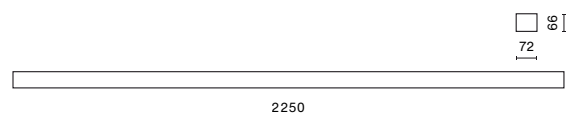
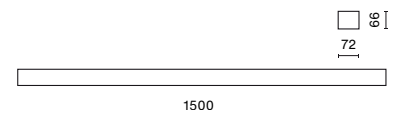

Luminous fittings sales indexes - pages: 40-43
 Blind segment 1,5 m IP20 index: 19.4377.0017.34
 Blind segment 1,5 m IP54 index: 19.4377.0021.34

Specifications are subject to change. Pictures of the luminaires may differ from reality.
 In accordance to EN13032: luminous flux tolerance +/- 10% and power tolerance +/- 10%. Find out more at luxiona.com

GRANVIA - STANDARD LUMINOUS FITTINGS



Light and electrical features

Light source	LED
Voltage	220..240 V, 50..60 Hz
Driver	standard on/off (E) / DIM DALI (EDD)
Operating temperature range [°C]	-20 ÷ 35
Power of luminaire [W]	31.7-119.1
Luminaire's light efficiency [lm/W]	152.5 - 191.2
Lx/By	L80/B10
SDCM (LED sources)	3
Protection against electric shock I	
Photobiological risk class (IEC/EN 62471)	RG0
Light distribution	Direct (I-down)
Beam	flood - 60° ÷ 90°, wideflood - 90° ÷ 120°, medium - 35° ÷ 60°, asymmetric, narrow - 15° ÷ 35°, superflood - over 120°
Lifetime of LED sources [h]	90000
Luminous flux LED [lm]	5936.7 - 20737.8

Mechanical features

Assembly	directly mounted to ceiling construction or surface mounted on slings
Material	steel sheet
Colour	RAL 9016 (white)

IP20

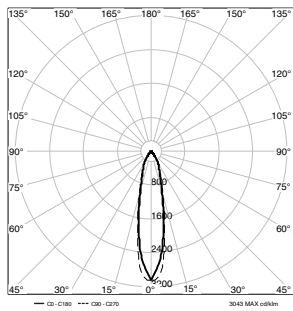

Narrow

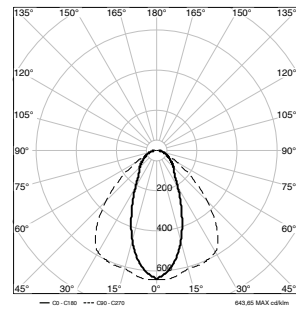

Oval

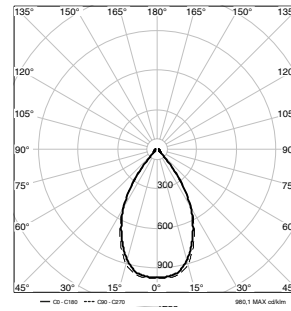

Medium

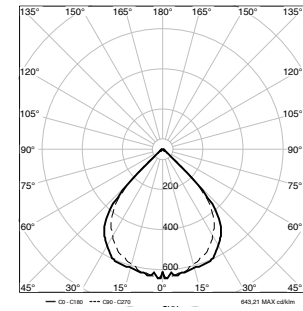

Flood

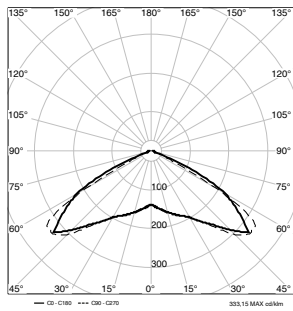

Super flood

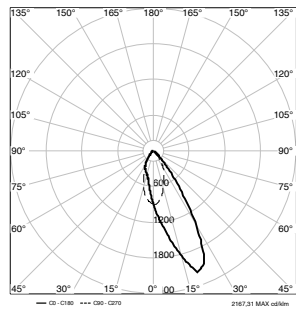

Asy

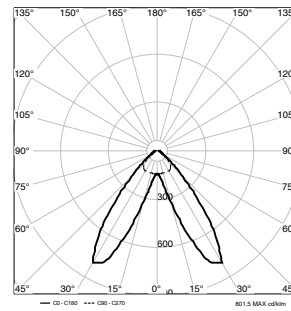

Double asy

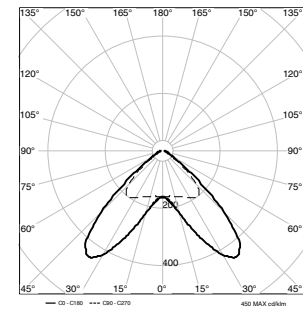

Double asy wide

IP54

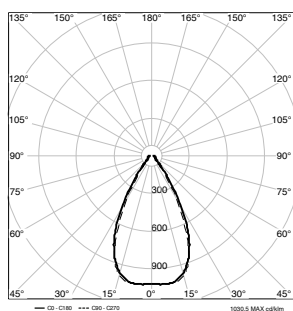

Medium

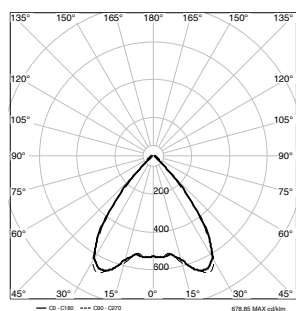

Flood

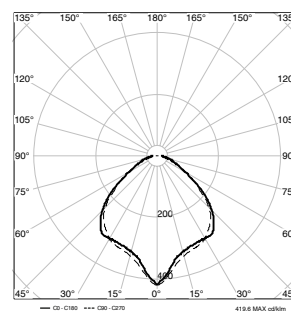

Wideflood

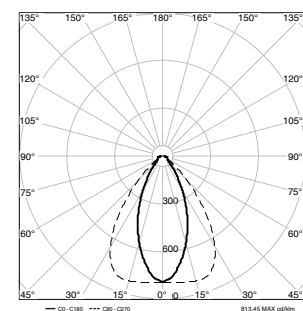

Oval

Specifications are subject to change. Pictures of the luminaires may differ from reality. In accordance to EN13032: luminous flux tolerance +/- 10% and power tolerance +/- 10%. Find out more at luxiona.com

GranVia selection guide

IP
20

4000K

90000h
L80/B10

4000K GranVia LUMINOUS FITTINGS @ 90 000h L80 IP20

	Length mm						2250					
	W		98		80		68		56		44	
	Lm range		16439 up to 17344		13695 up to 14449		11811 up to 12461		9933 up to 10480		7990 up to 8430	
	Lm/W max		177		181		184		187		190	
ON / OFF	Asy	19.4377.1C21.34	19.4377.1B21.34	19.4377.1A21.34	19.4377.1921.34	19.4377.1821.34	19.4377.1721.34					
	Double asy	19.4377.2C21.34	19.4377.2B21.34	19.4377.2A21.34	19.4377.2921.34	19.4377.2821.34	19.4377.2721.34					
	Double asy wide	19.4377.3C21.34	19.4377.3B21.34	19.4377.3A21.34	19.4377.3921.34	19.4377.3821.34	19.4377.3721.34					
	Oval	19.4377.6C21.34	19.4377.6B21.34	19.4377.6A21.34	19.4377.6921.34	19.4377.6821.34	19.4377.6721.34					
	Super flood	19.4377.7C21.34	19.4377.7B21.34	19.4377.7A21.34	19.4377.7921.34	19.4377.7821.34	19.4377.7721.34					
	Flood	19.4377.8C21.34	19.4377.8B21.34	19.4377.8A21.34	19.4377.8921.34	19.4377.8821.34	19.4377.8721.34					
	Medium	19.4377.4C21.34	19.4377.4B21.34	19.4377.4A21.34	19.4377.4921.34	19.4377.4821.34	19.4377.4721.34					
	Narrow	19.4377.5C21.34	19.4377.5B21.34	19.4377.5A21.34	19.4377.5921.34	19.4377.5821.34	19.4377.5721.34					
DALI	Asy	19.4377.1C23.34	19.4377.1B23.34	19.4377.1A23.34	19.4377.1923.34	19.4377.1823.34	19.4377.1723.34					
	Double asy	19.4377.2C23.34	19.4377.2B23.34	19.4377.2A23.34	19.4377.2923.34	19.4377.2823.34	19.4377.2723.34					
	Double asy wide	19.4377.3C23.34	19.4377.3B23.34	19.4377.3A23.34	19.4377.3923.34	19.4377.3823.34	19.4377.3723.34					
	Oval	19.4377.6C23.34	19.4377.6B23.34	19.4377.6A23.34	19.4377.6923.34	19.4377.6823.34	19.4377.6723.34					
	Super flood	19.4377.7C23.34	19.4377.7B23.34	19.4377.7A23.34	19.4377.7923.34	19.4377.7823.34	19.4377.7723.34					
	Flood	19.4377.8C23.34	19.4377.8B23.34	19.4377.8A23.34	19.4377.8923.34	19.4377.8823.34	19.4377.8723.34					
	Medium	19.4377.4C23.34	19.4377.4B23.34	19.4377.4A23.34	19.4377.4923.34	19.4377.4823.34	19.4377.4723.34					
	Narrow	19.4377.5C23.34	19.4377.5B23.34	19.4377.5A23.34	19.4377.5923.34	19.4377.5823.34	19.4377.5723.34					

	Length mm						1500					
	W		70		57		48		40		32	
	Lm range		11742 up to 12389		9782 up to 10321		8436 up to 8901		7095 up to 7486		5707 up to 6021	
	Lm/W max		177		181		184		187		190	
ON / OFF	Asy	19.4377.1621.34	19.4377.1521.34	19.4377.1421.34	19.4377.1321.34	19.4377.1221.34	19.4377.1121.34					
	Double asy	19.4377.2621.34	19.4377.2521.34	19.4377.2421.34	19.4377.2321.34	19.4377.2221.34	19.4377.2121.34					
	Double asy wide	19.4377.3621.34	19.4377.3521.34	19.4377.3421.34	19.4377.3321.34	19.4377.3221.34	19.4377.3121.34					
	Oval	19.4377.6621.34	19.4377.6521.34	19.4377.6421.34	19.4377.6321.34	19.4377.6221.34	19.4377.6121.34					
	Super flood	19.4377.7621.34	19.4377.7521.34	19.4377.7421.34	19.4377.7321.34	19.4377.7221.34	19.4377.7121.34					
	Flood	19.4377.8621.34	19.4377.8521.34	19.4377.8421.34	19.4377.8321.34	19.4377.8221.34	19.4377.8121.34					
	Medium	19.4377.4621.34	19.4377.4521.34	19.4377.4421.34	19.4377.4321.34	19.4377.4221.34	19.4377.4121.34					
	Narrow	19.4377.5621.34	19.4377.5521.34	19.4377.5421.34	19.4377.5321.34	19.4377.5221.34	19.4377.5121.34					
DALI	Asy	19.4377.1623.34	19.4377.1523.34	19.4377.1423.34	19.4377.1323.34	19.4377.1223.34	19.4377.1123.34					
	Double asy	19.4377.2623.34	19.4377.2523.34	19.4377.2423.34	19.4377.2323.34	19.4377.2223.34	19.4377.2123.34					
	Double asy wide	19.4377.3623.34	19.4377.3523.34	19.4377.3423.34	19.4377.3323.34	19.4377.3223.34	19.4377.3123.34					
	Oval	19.4377.6623.34	19.4377.6523.34	19.4377.6423.34	19.4377.6323.34	19.4377.6223.34	19.4377.6123.34					
	Super flood	19.4377.7623.34	19.4377.7523.34	19.4377.7423.34	19.4377.7323.34	19.4377.7223.34	19.4377.7123.34					
	Flood	19.4377.8623.34	19.4377.8523.34	19.4377.8423.34	19.4377.8323.34	19.4377.8223.34	19.4377.8123.34					
	Medium	19.4377.4623.34	19.4377.4523.34	19.4377.4423.34	19.4377.4323.34	19.4377.4223.34	19.4377.4123.34					
	Narrow	19.4377.5623.34	19.4377.5523.34	19.4377.5423.34	19.4377.5323.34	19.4377.5223.34	19.4377.5123.34					

IP
20

3000K

90000h
L80/B10

3000K GranVia LUMINOUS FITTINGS @ 90 000h L80 IP20

Length mm		2250					
W	119	98	80	68	56	44	
Lm range	18166 up to 19166	15688 up to 16552	13073 up to 13793	11277 up to 11898	9486 up to 10008	7632 up to 8052	
Lm/W max	161	169	173	176	178	181	
ON / OFF	Asy	19.4377.1C11.34	19.4377.1B11.34	19.4377.1A11.34	19.4377.1911.34	19.4377.1811.34	19.4377.1711.34
	Double asy	19.4377.2C11.34	19.4377.2B11.34	19.4377.2A11.34	19.4377.2911.34	19.4377.2811.34	19.4377.2711.34
	Double asy wide	19.4377.3C11.34	19.4377.3B11.34	19.4377.3A11.34	19.4377.3911.34	19.4377.3811.34	19.4377.3711.34
	Oval	19.4377.6C11.34	19.4377.6B11.34	19.4377.6A11.34	19.4377.6911.34	19.4377.6811.34	19.4377.6711.34
	Super flood	19.4377.7C11.34	19.4377.7B11.34	19.4377.7A11.34	19.4377.7911.34	19.4377.7811.34	19.4377.7711.34
	Flood	19.4377.8C11.34	19.4377.8B11.34	19.4377.8A11.34	19.4377.8911.34	19.4377.8811.34	19.4377.8711.34
	Medium	19.4377.4C11.34	19.4377.4B11.34	19.4377.4A11.34	19.4377.4911.34	19.4377.4811.34	19.4377.4711.34
	Narrow	19.4377.5C11.34	19.4377.5B11.34	19.4377.5A11.34	19.4377.5911.34	19.4377.5811.34	19.4377.5711.34
DALI	Asy	19.4377.1C13.34	19.4377.1B13.34	19.4377.1A13.34	19.4377.1913.34	19.4377.1813.34	19.4377.1713.34
	Double asy	19.4377.2C13.34	19.4377.2B13.34	19.4377.2A13.34	19.4377.2913.34	19.4377.2813.34	19.4377.2713.34
	Double asy wide	19.4377.3C13.34	19.4377.3B13.34	19.4377.3A13.34	19.4377.3913.34	19.4377.3813.34	19.4377.3713.34
	Oval	19.4377.6C13.34	19.4377.6B13.34	19.4377.6A13.34	19.4377.6913.34	19.4377.6813.34	19.4377.6713.34
	Super flood	19.4377.7C13.34	19.4377.7B13.34	19.4377.7A13.34	19.4377.7913.34	19.4377.7813.34	19.4377.7713.34
	Flood	19.4377.8C13.34	19.4377.8B13.34	19.4377.8A13.34	19.4377.8913.34	19.4377.8813.34	19.4377.8713.34
	Medium	19.4377.4C13.34	19.4377.4B13.34	19.4377.4A13.34	19.4377.4913.34	19.4377.4813.34	19.4377.4713.34
	Narrow	19.4377.5C13.34	19.4377.5B13.34	19.4377.5A13.34	19.4377.5913.34	19.4377.5813.34	19.4377.5713.34

Length mm		1500					
W	83	70	57	48	40	32	
Lm range	12976 up to 13690	11206 up to 11823	9338 up to 9852	8055 up to 8498	6775 up to 7149	5451 up to 5751	
Lm/W max	164	169	173	176	178	181	
ON / OFF	Asy	19.4377.1611.34	19.4377.1511.34	19.4377.1411.34	19.4377.1311.34	19.4377.1211.34	19.4377.1111.34
	Double asy	19.4377.2611.34	19.4377.2511.34	19.4377.2411.34	19.4377.2311.34	19.4377.2211.34	19.4377.2111.34
	Double asy wide	19.4377.3611.34	19.4377.3511.34	19.4377.3411.34	19.4377.3311.34	19.4377.3211.34	19.4377.3111.34
	Oval	19.4377.6611.34	19.4377.6511.34	19.4377.6411.34	19.4377.6311.34	19.4377.6211.34	19.4377.6111.34
	Super flood	19.4377.7611.34	19.4377.7511.34	19.4377.7411.34	19.4377.7311.34	19.4377.7211.34	19.4377.7111.34
	Flood	19.4377.8611.34	19.4377.8511.34	19.4377.8411.34	19.4377.8311.34	19.4377.8211.34	19.4377.8111.34
	Medium	19.4377.4611.34	19.4377.4511.34	19.4377.4411.34	19.4377.4311.34	19.4377.4211.34	19.4377.4111.34
	Narrow	19.4377.5611.34	19.4377.5511.34	19.4377.5411.34	19.4377.5311.34	19.4377.5211.34	19.4377.5111.34
DALI	Asy	19.4377.1613.34	19.4377.1513.34	19.4377.1413.34	19.4377.1313.34	19.4377.1213.34	19.4377.1113.34
	Double asy	19.4377.2613.34	19.4377.2513.34	19.4377.2413.34	19.4377.2313.34	19.4377.2213.34	19.4377.2113.34
	Double asy wide	19.4377.3613.34	19.4377.3513.34	19.4377.3413.34	19.4377.3313.34	19.4377.3213.34	19.4377.3113.34
	Oval	19.4377.6613.34	19.4377.6513.34	19.4377.6413.34	19.4377.6313.34	19.4377.6213.34	19.4377.6113.34
	Super flood	19.4377.7613.34	19.4377.7513.34	19.4377.7413.34	19.4377.7313.34	19.4377.7213.34	19.4377.7113.34
	Flood	19.4377.8613.34	19.4377.8513.34	19.4377.8413.34	19.4377.8313.34	19.4377.8213.34	19.4377.8113.34
	Medium	19.4377.4613.34	19.4377.4513.34	19.4377.4413.34	19.4377.4313.34	19.4377.4213.34	19.4377.4113.34
	Narrow	19.4377.5613.34	19.4377.5513.34	19.4377.5413.34	19.4377.5313.34	19.4377.5213.34	19.4377.5113.34

GranVia selection guide

IP
54

4000K

90000h
L80/B10

4000K GranVia LUMINOUS FITTINGS @ 90 000h L80 IP54

Length mm		2250					
W	119	98	80	68	56	44	
Lm range	19484 up to 20220	16821 up to 17456	14013 up to 14542	12086 up to 12542	10164 up to 10548	8176 up to 8484	
Lm/W max	170	178	182	185	188	191	
ON / OFF	Wideflood	19.4380.3C21.34	19.4380.3B21.34	19.4380.3A21.34	19.4380.3921.34	19.4380.3821.34	19.4380.3721.34
	Flood	19.4380.4C21.34	19.4380.4B21.34	19.4380.4A21.34	19.4380.4921.34	19.4380.4821.34	19.4380.4721.34
	Oval	19.4380.2C21.34	19.4380.2B21.34	19.4380.2A21.34	19.4380.2921.34	19.4380.2821.34	19.4380.2721.34
	Medium	19.4380.1C21.34	19.4380.1B21.34	19.4380.1A21.34	19.4380.1921.34	19.4380.1821.34	19.4380.1721.34
DALI	Wideflood	19.4380.3C23.34	19.4380.3B23.34	19.4380.3A23.34	19.4380.3923.34	19.4380.3823.34	19.4380.3723.34
	Flood	19.4380.4C23.34	19.4380.4B23.34	19.4380.4A23.34	19.4380.4923.34	19.4380.4823.34	19.4380.4723.34
	Oval	19.4380.2C23.34	19.4380.2B23.34	19.4380.2A23.34	19.4380.2923.34	19.4380.2823.34	19.4380.2723.34
	Medium	19.4380.1C23.34	19.4380.1B23.34	19.4380.1A23.34	19.4380.1923.34	19.4380.1823.34	19.4380.1723.34

Length mm		1500					
W	83	70	57	48	40	32	
Lm range	13918 up to 14443	12015 up to 12469	10010 up to 10387	8633 up to 8958	7260 up to 7534	5840 up to 6060	
Lm/W max	173	178	182	185	188	191	
ON / OFF	Wideflood	19.4380.3621.34	19.4380.3521.34	19.4380.3421.34	19.4380.3321.34	19.4380.3221.34	19.4380.3121.34
	Flood	19.4380.4621.34	19.4380.4521.34	19.4380.4421.34	19.4380.4321.34	19.4380.4221.34	19.4380.4121.34
	Oval	19.4380.2621.34	19.4380.2521.34	19.4380.2421.34	19.4380.2321.34	19.4380.2221.34	19.4380.2121.34
	Medium	19.4380.1621.34	19.4380.1521.34	19.4380.1421.34	19.4380.1321.34	19.4380.1221.34	19.4380.1121.34
DALI	Wideflood	19.4380.3623.34	19.4380.3523.34	19.4380.3423.34	19.4380.3323.34	19.4380.3223.34	19.4380.3123.34
	Flood	19.4380.4623.34	19.4380.4523.34	19.4380.4423.34	19.4380.4323.34	19.4380.4223.34	19.4380.4123.34
	Oval	19.4380.2623.34	19.4380.2523.34	19.4380.2423.34	19.4380.2323.34	19.4380.2223.34	19.4380.2123.34
	Medium	19.4380.1623.34	19.4380.1523.34	19.4380.1423.34	19.4380.1323.34	19.4380.1223.34	19.4380.1123.34

IP
54

3000K

90000h
L80/B10

3000K GranVia LUMINOUS FITTINGS @ 90 000h L80 IP54

Length mm		2250					
W	119	98	80	68	56	44	
Lm range	18589 up to 19290	16053 up to 16659	13377 up to 13882	11539 up to 11975	9706 up to 10073	7809 up to 8104	
Lm/W max	162	170	174	177	180	183	
ON / OFF	Wideflood	19.4380.3C11.34	19.4380.3B11.34	19.4380.3A11.34	19.4380.3911.34	19.4380.3811.34	19.4380.3711.34
	Flood	19.4380.4C11.34	19.4380.4B11.34	19.4380.4A11.34	19.4380.4911.34	19.4380.4811.34	19.4380.4711.34
	Oval	19.4380.2C11.34	19.4380.2B11.34	19.4380.2A11.34	19.4380.2911.34	19.4380.2811.34	19.4380.2711.34
	Medium	19.4380.1C11.34	19.4380.1B11.34	19.4380.1A11.34	19.4380.1911.34	19.4380.1811.34	19.4380.1711.34
DALI	Wideflood	19.4380.3C13.34	19.4380.3B13.34	19.4380.3A13.34	19.4380.3913.34	19.4380.3813.34	19.4380.3713.34
	Flood	19.4380.4C13.34	19.4380.4B13.34	19.4380.4A13.34	19.4380.4913.34	19.4380.4813.34	19.4380.4713.34
	Oval	19.4380.2C13.34	19.4380.2B13.34	19.4380.2A13.34	19.4380.2913.34	19.4380.2813.34	19.4380.2713.34
	Medium	19.4380.1C13.34	19.4380.1B13.34	19.4380.1A13.34	19.4380.1913.34	19.4380.1813.34	19.4380.1713.34

Length mm		1500					
W	83	70	57	48	40	32	
Lm range	13278 up to 13779	11466 up to 11899	9555 up to 9916	8242 up to 8553	6933 up to 7195	5578 up to 5788	
Lm/W max	165	170	174	177	179	183	
ON / OFF	Wideflood	19.4380.3611.34	19.4380.3511.34	19.4380.3411.34	19.4380.3311.34	19.4380.3211.34	19.4380.3111.34
	Flood	19.4380.4611.34	19.4380.4511.34	19.4380.4411.34	19.4380.4311.34	19.4380.4211.34	19.4380.4111.34
	Oval	19.4380.2611.34	19.4380.2511.34	19.4380.2411.34	19.4380.2311.34	19.4380.2211.34	19.4380.2111.34
	Medium	19.4380.1611.34	19.4380.1511.34	19.4380.1411.34	19.4380.1311.34	19.4380.1211.34	19.4380.1111.34
DALI	Wideflood	19.4380.3613.34	19.4380.3513.34	19.4380.3413.34	19.4380.3313.34	19.4380.3213.34	19.4380.3113.34
	Flood	19.4380.4613.34	19.4380.4513.34	19.4380.4413.34	19.4380.4313.34	19.4380.4213.34	19.4380.4113.34
	Oval	19.4380.2613.34	19.4380.2513.34	19.4380.2413.34	19.4380.2313.34	19.4380.2213.34	19.4380.2113.34
	Medium	19.4380.1613.34	19.4380.1513.34	19.4380.1413.34	19.4380.1313.34	19.4380.1213.34	19.4380.1113.34

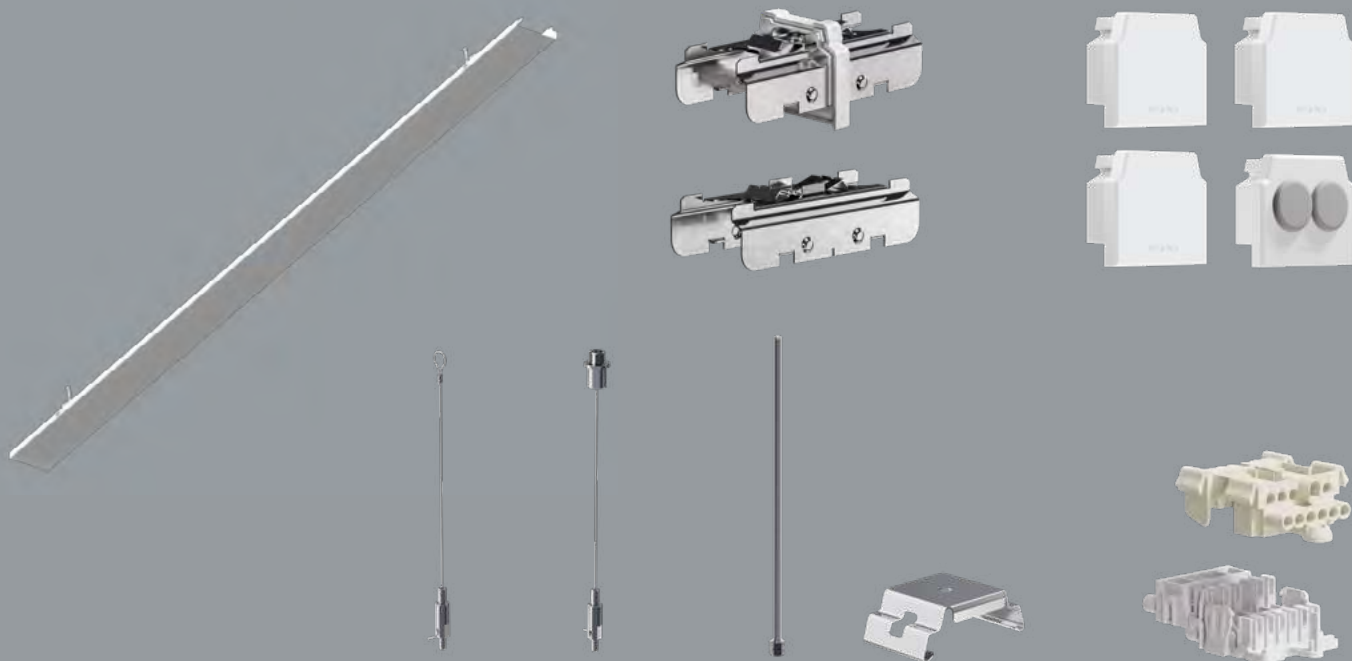

ACCESSORIES

Setting a GranVia trunking rail system requires essential accessories to ensure quick and tool-less installation. Our connector accessory is designed to easily join several rails to form continuous lines of light, saving time and effort. Chosen endcaps are necessary to complete light lines and ensure IP20 or IP54 protection levels. Adjustable suspensions with slings or rod bars are used with a bracket accessory to easily suspend the rail and set the desired height for suspended installations. These required accessories make GranVia a high-performance lighting solution, that can be installed in a quick, effortless way and with maximum efficiency.

Type of accessory	Product name	Product index
Suspension bracket	GRANVIA / GRANVIA PRO TRUNKING RAIL SUSPENSION BRACKET	19.4377.0016.00
Suspension	SUSPENSION NEW TYPE-C LENGHT-1,5 METER WITHOUT WIRE 1-POINT	6E1-9875-3-1,5
Suspension	SUSPENSION NEW TYPE-E LENGHT-1,5 METER WITHOUT WIRE 1-POINT	19.3272.1205.00
Suspension	SUSPENSION NEW TYPE-W LENGHT-1,0 METRA WITHOUT WIRE 1-POINT	19.3272.1801.00
Rail connector	GRANVIA / GRANVIA PRO TRUNKING RAIL CONNECTOR	19.4377.0013.00
Rail connector	GRANVIA IP54 / GRANVIA IP54 PRO TRUNKING RAIL CONNECTOR	19.4377.0020.00
Blind segment	GRANVIA / GRANVIA PRO BLIND SECTION COVER 34 / L-1500MM	19.4377.0017.34
Blind segment	GRANVIA IP54 / GRANVIA IP54 PRO BLIND SECTION COVER 34 / L-1500MM	19.4377.0021.34
End-cap	GRANVIA / GRANVIA PRO TRUNKING RAIL END-CAP 34	19.4377.0014.34
End-cap	GRANVIA / GRANVIA PRO TRUNKING RAIL END-CAP WITH POWER IN 34	19.4377.0015.34
End-cap	GRANVIA IP54 / GRANVIA IP54 PRO TRUNKING RAIL END-CAP 34	19.4377.0018.34
Power/end connector	GRANVIA IP54 / GRANVIA IP54 PRO TRUNKING RAIL END-CAP WITH POWER IN 34	19.4377.0019.34
Power/end connector	GRANVIA / GRANVIA PRO SET OF POWER/END CONNECTOR 11X WIRES	19.4377.0029.00

Specifications are subject to change. Pictures of the luminaires may differ from reality.
 In accordance to EN13032: luminous flux tolerance +/- 10% and power tolerance +/- 10%. Find out more at luxiona.com

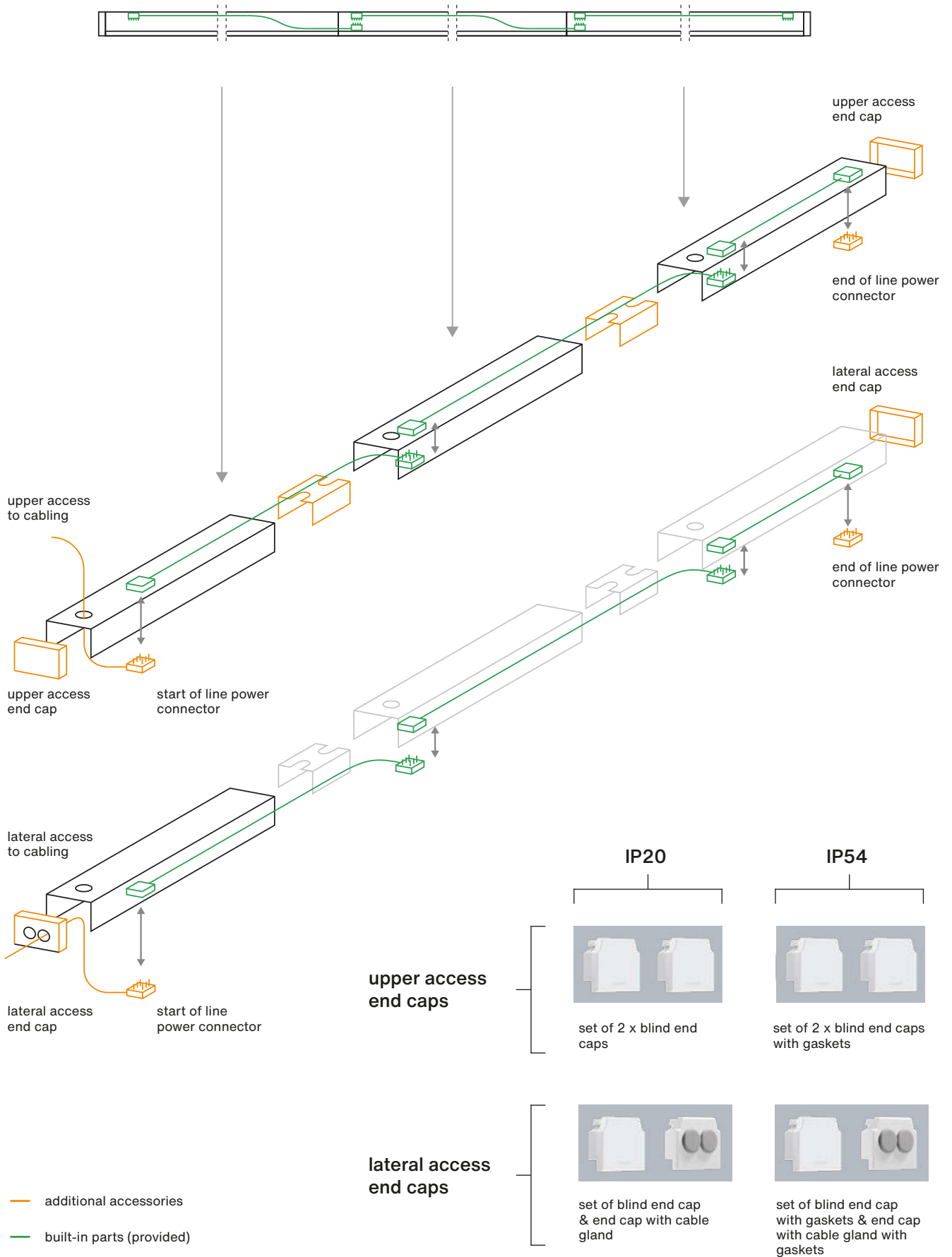

Specifications are subject to change. Pictures of the luminaires may differ from reality.
 In accordance to EN13032: luminous flux tolerance +/- 10% and power tolerance +/- 10%. Find out more at luxiona.com

New additional modules

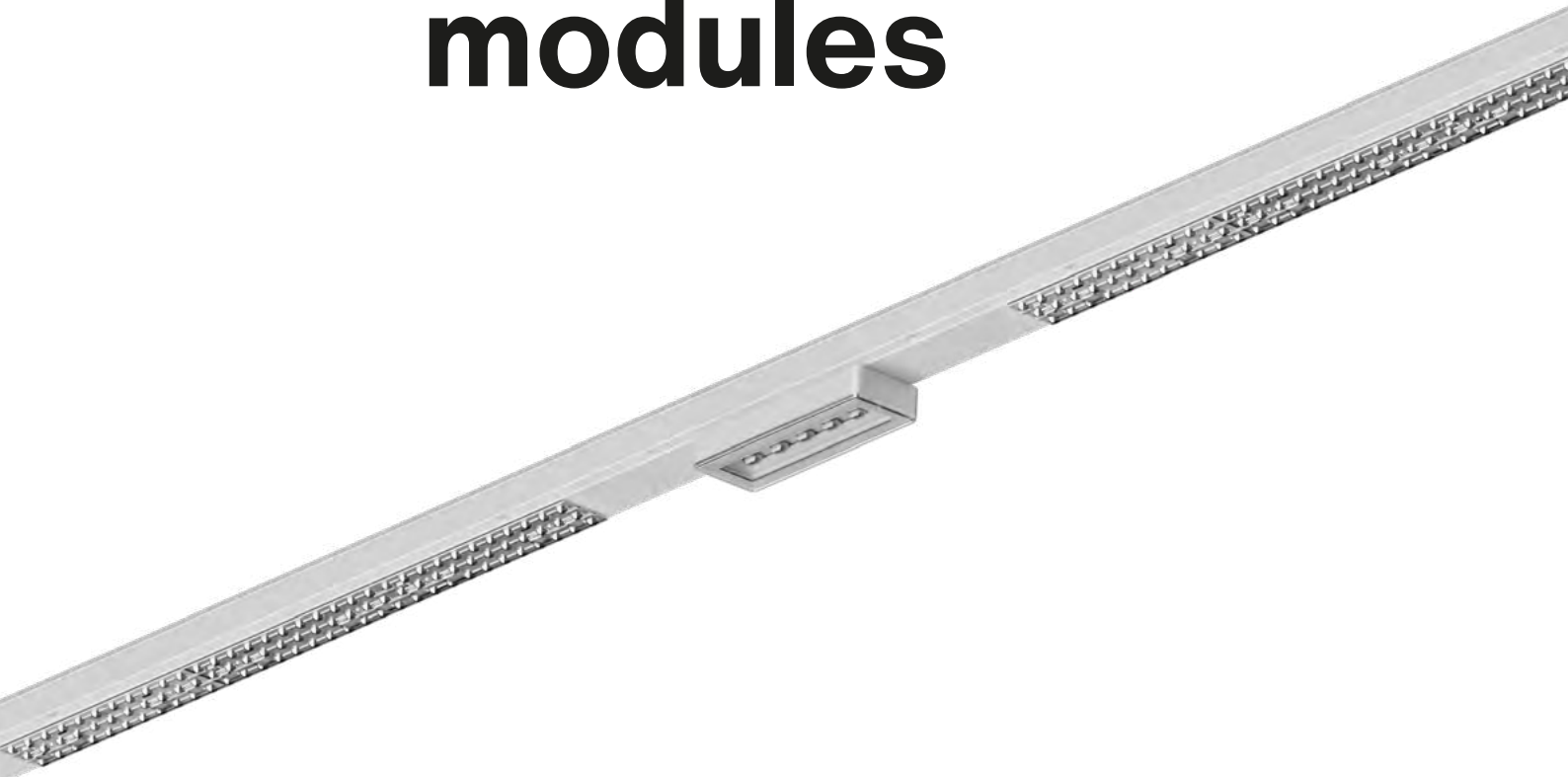

GranVia expands product range with new lighting modules for different tasks

The GranVia trunking rail system is evolving into a fully integrated system that meets diverse lighting needs in retail and industrial environments. Designed for seamless technology integration, the system supports general, accent, safety, and control lighting, offering 100% flexibility along its continuous-row structure.

With trunking featuring additional control lines and independent emergency lighting circuits, GranVia allows for effortless integration of new spotlights, sensors, emergency lighting modules, and industrial high-bay solutions. By combining advanced lighting controls and modular adaptability, GranVia delivers a sustainable, cost-efficient, and future-proof solution that balances functionality and aesthetics.



Luxcan Pro*

High-precision spotlights enhance merchandise with exceptional colour rendering (CRI) using specialized LEDs and customizable optical systems. These can be tailored to highlight specific products, such as fresh food, fish, meat, or baked goods, making them ideal for supermarket displays.



Emergency module*

Emergency-ready modules seamlessly integrate into the GranVia continuous-row system, ensuring reliable illumination via dedicated circuits during power outages. Compact and energy-efficient, they meet stringent safety standards while preserving the system's aesthetic and delivering long-lasting performance.

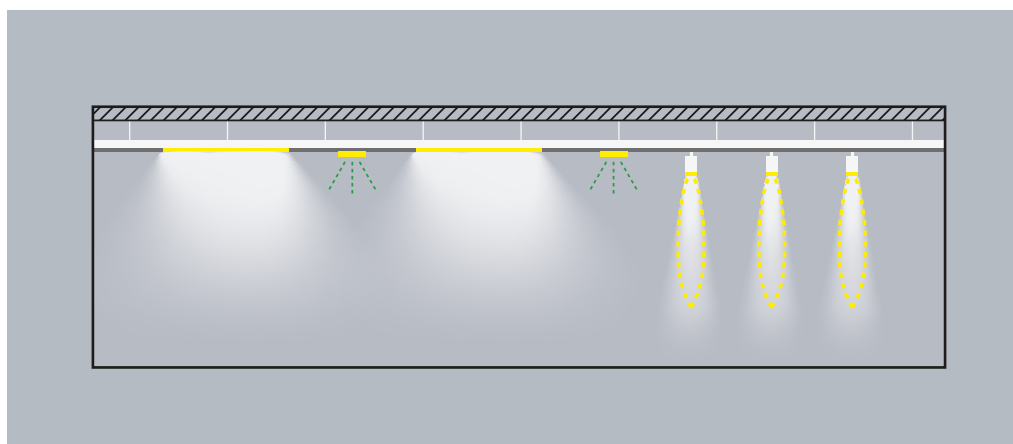

LUXIONA worldwide



Commercial offices:

Spain, Poland, France, Italy,
Germany

Logistics centre:

Spain

Production:

Poland / Spain (emergency)

LUXIONA

LUXIONA Headquarters

C/ Diputació, 180, 4A
08011 Barcelona
Spain
+34 938 466 909
info@luxiona.com

Spain

C/ Diputació, 180, 4A
08011 Barcelona
Spain
+34 938 466 909
info@luxiona.com

Germany

Berlin Leuchtenfabrik,
Haus A / 1. Etage
Edisonstr. 63
12459 Berlin, Germany
+49 3040 535 600
info@luxiona.de

France

7 Rue Colonel Chambonnet
69500 Bron
France
+33 472 146 666
info.france@luxiona.com

Marketing

marketing@luxiona.com

luxiona.com

support@luxiona.com

Poland

ul. Komitetu Obrony Robotników 48
02-146 Warszawa
Poland
+48 22 721 72 72
info.poland@luxiona.com

Italy

Via Luigi Cadamosto 4
26900 Lodi (LO)
Italy
+39 0 298 274 010
info.italy@luxiona.com

Export

Export Department
+48 505 695 638
customer.care@luxiona.com

Purchasing

globalpurchasing@luxiona.com

[Linkedin.com/company/luxiona](https://www.linkedin.com/company/luxiona)
 [Facebook.com/luxionagroup](https://www.facebook.com/luxionagroup)
 [Instagram.com/luxionagroup](https://www.instagram.com/luxionagroup)
 [YouTube: LUXIONA Group](https://www.youtube.com/LUXIONA_Group)





luxiona.com